



KATALÓG 04/2026

Cenník technických izolácií

špecializovaný veľkoobchod

IZOLAČNÉ MATERIÁLY VYSOKEJ KVALITY
ODBORNÉ TECHNICKÉ PORADENSTVO
ŽILINA, BRATISLAVA, KOŠICE



IZOLÁCIE PRE TZB

chladenie, kúrenie, vzduchotechnika

IZOLÁCIE PRE PRIEMYSEL

technológie od kryogeniky po žiarotechniku

PROFESIONÁLNE IZOLAČNÉ SYSTÉMY

pre médiá od -260°C do 1430°C

povrchové úpravy ochrany izolácií, príslušenstvo

NAVŠTÍVTE NÁŠ NOVÝ E-SHOP
www.azflex.sk

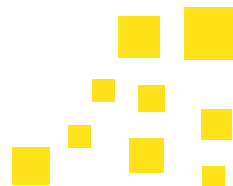

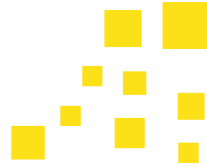

NOVÝ E-SHOP AZ FLEX

V prehľadnom internetovom obchode www.azflex.sk si môžete objednať vybrané produkty a príslušenstvo z oblasti technických izolácií, ako aj suchej výstavby a penového skla.

Sortiment, ktorý nájdete v našom e-shope:

- izolácie pre TZB a priemysel
- akustické izolácie
- protipožiarne systémy
- kazetové stropy, akustický sadrokartón VOGL
- dizajnové a akustické stropné podhlady
- penové sklo FOAMGLAS

www.azflex.sk

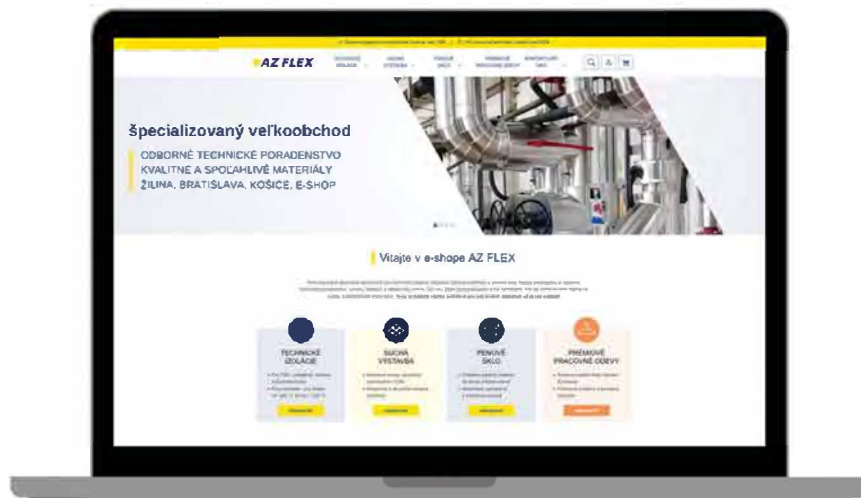

OBCHODNÉ PODMIENKY

- Ceny sú uvedené v EUR bez DPH, platné v čase vydania cenníka,
- Platnosť cenníka je do vydania novej verzie cenníka,
- Ceny v cenníku sú uvedené pre odbery, ktoré je možné realizovať s termínom dodania do konca platnosti cenníka,
- Izolácie s dlhším dodacím termínom budú dodávané v cenách podľa nových podmienok stanovených výrobcami,
- Predávajúci si vyhradzuje právo zmeniť ceny a výšku zliav v prípade zmeny nákupných alebo dovozných podmienok.

- Celé znenie Všeobecných obchodných podmienok nájdete na webe www.azflex.sk.
- Cenník si môžete stiahnuť v pdf verzii z web stránky www.azflex.sk.



TRUBICE ARMAFLEX ULTIMA



Syntetický kaučuk (elastomer) vyrobený technológiou Armaprene s vylepšenými vlastnosťami, ktoré spomaľujú horenie a znižujú tvorbu dymu. Použitie pre teploty od -50°C(-200°C) do +110°C. Dĺžka trubice 2m. Faktor difúzneho odporu $\mu > 7\ 000$. Súčiniteľ tepelnej vodivosti $\lambda 0\ ^\circ\text{C} = 0,040\ \text{W/m.K}$. Trieda reakcie na oheň B(L)-s1, d0 (pásky B-s2, d0)

Vonk. Ø potr. (mm)	Armaflex ULTIMA			Armaflex ULTIMA			Armaflex ULTIMA			Armaflex ULTIMA		
	Hr. izolácie 9 mm			Hr. izolácie 13 mm			Hr. izolácie 19 mm			Hr. izolácie 25 mm		
	Obj. kód	bm/ bal.	EUR/bm bez DPH	Obj. kód	bm/ bal.	EUR/bm bez DPH	Obj. kód	bm/ bal.	EUR/bm bez DPH	Obj. kód	bm/ bal.	EUR/bm bez DPH
12	UD 012 / 9	192	26,65 €	UD 012 / 13	130	29,70 €						
15	UD 015 / 9	180	27,60 €	UD 015 / 13	112	31,30 €	UD 015 / 19	64	57,70 €			
18	UD 018 / 9	150	28,80 €	UD 018 / 13	98	33,90 €	UD 018 / 19	58	58,85 €	UD 018 / 25	46	84,85 €
22	UD 022 / 9	124	30,35 €	UD 022 / 13	88	35,20 €	UD 022 / 19	56	67,15 €	UD 022 / 25	36	89,85 €
28	UD 028 / 9	96	31,60 €	UD 028 / 13	64	38,40 €	UD 028 / 19	40	72,30 €	UD 028 / 25	36	97,15 €
35	UD 035 / 9	70	36,10 €	UD 035 / 13	56	42,85 €	UD 035 / 19	40	78,55 €	UD 035 / 25	28	106,60 €
42	UD 042 / 9	56	38,90 €	UD 042 / 13	48	51,95 €	UD 042 / 19	24	91,75 €	UD 042 / 25	24	119,00 €
48	UD 048 / 9	52	42,00 €	UD 048 / 13	40	55,10 €	UD 048 / 19	24	93,80 €	UD 048 / 25	20	130,60 €
54	UD 054 / 9	42	45,45 €	UD 054 / 13	36	60,50 €	UD 054 / 19	24	124,60 €	UD 054 / 25	18	137,50 €
60	UD 060 / 9	40	50,70 €	UD 060 / 13	28	68,75 €	UD 060 / 19	16	139,00 €	UD 060 / 25	18	154,40 €
64	UD 064 / 9	28	59,40 €	UD 064 / 13	26	76,80 €	UD 064 / 19	16	150,75 €	UD 064 / 25	16	194,95 €
76	UD 076 / 9	32	64,20 €	UD 076 / 13	24	85,75 €	UD 076 / 19	16	153,50 €	UD 076 / 25	12	223,85 €
89	UD 089 / 9	24	68,85 €	UD 089 / 13	18	97,75 €	UD 089 / 19	16	164,10 €	UD 089 / 25	12	240,25 €

PÁSY ARMAFLEX ULTIMA

Izolačné pásky zo syntetického kaučuku.

Armaflex ULTIMA			
Hr. izol. (mm)	Rola (šírka 1m) Obj.kód	m ² / bal.	EUR/m2 bez DPH
6	UD 06 -99 -E	15	134,70 €
9	UD 09 -99 -E	10	204,90 €
13	UD 13 -99 -E	8	289,95 €
19	UD 19 -99 -E	6	400,20 €
25	UD 25 -99 -E	4	504,40 €
32	UD 32 -99 -E	3	

Samolepiace pásky zo syntetického kaučuku

Armaflex ULTIMA (A) samolep			
Hr izol (mm)	Rola (šírka 1m) Obj.kód	m ² / bal.	EUR/m2 bez DPH
6	UD 06 -99 -EA	15	
9	UD 09 -99 -EA	10	237,25 €
13	UD 13 -99 -EA	8	317,25 €
19	UD 19 -99 -EA	6	426,15 €
25	UD 25 -99 -EA	4	527,15 €
32	UD 32 -99 -EA	3	

ZÁVESY ARMAFIX ULTIMA



Chladové izolačné závesy do systému Armaflex ULTIMA.

Použitie pre teploty od -50°C do +110°C.

Objemová hmotnosť 95-105kg/m³. Súčiniteľ tepelnej vodivosti λ 0 °C = 0,040 W/m.K.

Trieda reakcie na oheň v systéme Armaflex ULTIMA B(L)-s1, d0 (pásy B-s2, d0).

Vonk. Ø potr. (mm)	Armafix ULTIMA					Armafix ULTIMA					Armafix ULTIMA				
	Hr. izolácie 13 mm					Hr. izolácie 19mm					Hr. izolácie 25mm				
	Vzdialenosť závesov (m)	Vonkajší Ø závesov	Obj. kód	ks/bal.	EUR/ks bez DPH	Vzdialenosť závesov (m)	Vonkajší Ø závesov	Obj. kód	ks/bal.	EUR/ks bez DPH	Vzdialenosť závesov (m)	Vonkajší Ø závesov	Obj. kód	ks/bal.	EUR/ks bez DPH
12	2	38	ULP 13 10/12	32	24,05 €	2	50	ULP 19 10/12	28	26,90 €					
18	2	44	ULP 13 15/18	32	24,50 €	2	56	ULP 19 15/18	28	27,50 €	2,25	68	ULP 25 15/18	28	36,85 €
22	2,75	48	ULP 13 22/25	32	27,65 €	2,75	60	ULP 19 22/25	28	30,25 €	2,75	72	ULP 25 22/25	28	40,10 €
28	3	54	ULP 13 28/30	32	31,00 €	3	66	ULP 19 28/30	28	35,55 €	3	78	ULP 25 28/30	28	45,65 €
35	3,5	61	ULP 13 35/38	28	33,55 €	3,5	73	ULP 19 35/38	24	39,05 €	3,5	85	ULP 25 35/38	24	52,05 €
42	3,75	68	ULP 13 42/45	28	34,00 €	3,75	80	ULP 19 42/45	24	39,90 €	3,75	92	ULP 25 42/45	24	54,80 €
48	4,25	74	ULP 13 48	28	35,70 €	4,25	86	ULP 19 48	24	41,50 €	4,25	98	ULP 25 48	24	59,45 €
54	4,25	80	ULP 13 54/57	28	36,60 €	4,25	92	ULP 19 54/57	24	43,45 €	4,25	104	ULP 25 54/57	24	62,30 €
60	4,75	86	ULP 13 60/64	24	45,65 €	4,75	98	ULP 19 60/64	20	53,50 €	4,75	110	ULP 25 60/64	20	76,90 €
76	5,5	102	ULP 13 76/80	20	49,95 €	5,5	114	ULP 19 76/80	16	62,70 €	5,5	126	ULP 25 76/80	16	90,50 €
89	6	117	ULP 13 89	16	57,90 €	6	129	ULP 19 89	12	74,70 €	6	141	ULP 25 89	12	107,20 €
110						6	150	ULP 19 102/108	12	94,10 €					
114						6	154	ULP 19 110/114	12	111,00 €					
133						6	173	ULP 19 133/140	12	133,25 €	6	185	ULP 25 133/140	12	135,05 €
160											6	214	ULP 25 160	6	153,95 €
168						6	210	ULP 19 165/168	6	154,55 €	6	222	ULP 25 165/168	6	175,45 €
180						6	222	ULP 19 180	3	204,00 €					
200						6	242	ULP 19 204	4	224,40 €	6	254	ULP 25 204	4	243,95 €
219						6	261	ULP 19 216/219	4	246,85 €	6	273	ULP 25 216/219	4	278,05 €
254						6	296	ULP 19 254	3	271,50 €	6	308	ULP 25 254	3	316,95 €
267						6	309	ULP 19 267/273	3	298,65 €	6	321	ULP 25 267/273	3	331,25 €
306											6	360	ULP 25 306	1	361,35 €
324											4,5	378	ULP 25 324	1	411,95 €
356						4,2	398	ULP 19 356	6	372,60 €	4,2	410	ULP 25 356	3	469,60 €
406											4,2	460	ULP 25 406	6	535,35 €
457											3,7	511	ULP 25 457	4	610,35 €

Armaflex®
ACE Plus

**PRUŽNÁ IZOLÁCIA NA BÁZE
FLEXIBILNEJ ELASTOMERICKEJ
PENY ARMAFLEX®**



- Spoľahlivá ochrana proti kondenzácií na báze technológie Armaflex s uzavretou štruktúrou buniek
- Účinné zníženie tepelných strát
- Optimálne zloženie sortimentu pre ľahké použitie na väčšine veľkostí potrubí a vzduchotechnických rozvodov
- Zvýšená bezpečnosť sústavy pri montáži s izolačnými závesmi ARMAFIX a lepidlom Armaflex
- Osvedčenie požiarnej klasifikácie eurotrieda B/BL-s3,d0 pre celý sortiment

TRUBICE AF ARMAFLEX

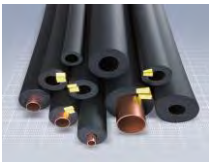

Syntetický kaučuk (elastomer) čiernej farby, pre teploty od -50°C(-200°C) do +110°C.
 Vysoko ohybný izolačný materiál so štruktúrou uzavretých buniek, vysokým odporom proti difúzii vodnej pary a nízkou tepelnou vodivosťou.
 Dĺžka 2m. Faktor difúzneho odporu $\mu > 10\ 000$. Súčiniteľ tep. vodivosti $\lambda\ 0\ ^\circ\text{C} = 0,033\ \text{W/m.K}$. Trieda reakcie na oheň B(L)-s3,d0.

Vonk. Ø potr.	Armaflex AF1				Armaflex AF2				Armaflex AF3			
	Hr. izolácie 7,5 mm až 10 mm				Hr. izolácie 11 mm až 16 mm				Hr. izolácie 13 mm až 19 mm			
	Hr. izol.	Obj. kód	bm/bal.	EUR/bm bez DPH	Hr. izol.	Obj. kód	bm/bal.	EUR/bm bez DPH	Hr. izol.	Obj. kód	bm/bal.	EUR/bm bez DPH
6	7,0	AF1 006	360	3,05 €	9,5	AF2 006	288	4,05 €				
8	7,0	AF1 008	310	3,15 €	10,0	AF2 008	240	4,30 €				
10	7,5	AF1 010	300	3,30 €	11,0	AF2 010	170	4,65 €	12,5	AF3 010	156	7,10 €
12	7,5	AF1 012	234	3,50 €	11,0	AF2 012	168	4,90 €	13,0	AF3 012	144	7,50 €
15	8,0	AF1 015	192	3,60 €	11,5	AF2 015	130	5,55 €	14,0	AF3 015	108	8,90 €
18	8,0	AF1 018	140	3,85 €	11,5	AF2 018	120	5,95 €	14,0	AF3 018	96	9,25 €
22	8,5	AF1 022	132	4,30 €	12,0	AF2 022	100	6,50 €	14,5	AF3 022	84	10,45 €
25	8,5	AF1 025	108	4,60 €	12,5	AF2 025	88	6,70 €				
28	8,5	AF1 028	100	4,80 €	12,5	AF2 028	84	7,00 €	15,5	AF3 028	64	12,30 €
30	9,0	AF1 030	96	5,10 €	12,5	AF2 030	72	7,70 €				
35	9,0	AF1 035	76	5,45 €	13,0	AF2 035	62	8,60 €	16,0	AF3 035	46	14,35 €
38	9,0	AF1 038	70	5,70 €								
42	9,0	AF1 042	60	6,20 €	13,5	AF2 042	48	9,50 €	16,5	AF3 042	40	16,15 €
45	9,0	AF1 045	56	6,75 €								
48	9,0	AF1 048	50	7,20 €	13,5	AF2 048	44	11,45 €	16,5	AF3 048	32	19,65 €
54	9,0	AF1 054	48	8,40 €	13,5	AF2 054	36	13,90 €				
57	9,0	AF1 057	40	9,35 €	14,0	AF2 057	34	14,65 €				
60	9,0	AF1 060	36	10,50 €	14,0	AF2 060	32	15,10 €	17,0	AF3 060	24	25,05 €
64	9,5	AF1 064	32	11,65 €					17,0	AF3 064	20	26,55 €
70	9,5	AF1 070	32	12,80 €	14,0	AF2 070	28	17,70 €	17,5	AF3 070	18	28,65 €
76	9,5	AF1 076	28	14,00 €	14,0	AF2 076	28	18,95 €	17,5	AF3 076	16	30,95 €
80	9,5	AF1 080	24	15,35 €	14,5	AF2 080	24	20,80 €				
89	9,5	AF1 089	22	16,95 €	14,5	AF2 089	22	22,60 €	18,0	AF3 089	16	34,80 €
102	9,5	AF1 102	16	23,45 €	14,5	AF2 102	18	29,65 €				
108	9,5	AF1 108	16	25,60 €	14,5				18,0	AF3 108	12	48,40 €
114	9,5	AF1 114	16	27,50 €	15,0	AF2 114	16	35,40 €	18,5	AF3 114	12	51,00 €
125	9,5	AF1 125	12	36,05 €	15,0	AF2 125	12	43,60 €	18,5	AF3 125	12	58,60 €
133					15,5	AF2 133	12	45,65 €	18,5	AF3 133	8	60,95 €
140	10,0	AF1 140	12	38,65 €	15,5	AF2 140	8	47,05 €	19,0	AF3 140	8	64,10 €
160	10,0	AF1 160	8	44,35 €	16,0	AF2 160	8	55,00 €	19,0	AF3 160	6	73,80 €

TRUBICE AF ARMAFLEX

Vonk. Ø potr. (mm)	Armaflex AF4				Armaflex AF 5				Armaflex AF 6			
	Hr. izolácie 16 mm až 25 mm				Hr. izolácie 25 mm až 32 mm				Hr. izolácie 32 mm až 45 mm			
	Hr. izol.	Obj. kód	bm/ bal.	EUR/bm bez DPH	Hr. izol.	Obj. kód	bm/ bal.	EUR/bm bez DPH	Hr. izol.	Obj. kód	bm/ bal.	EUR/bm bez DPH
10	15,5	AF4 010	110	8,00 €					32,0	AF6 010	40	18,20 €
12	16,0	AF4 012	100	8,40 €					32,0	AF6 012	36	19,00 €
15	17,0	AF4 015	88	10,15 €					32,0	AF6 015	32	19,75 €
18	17,5	AF4 018	70	10,45 €	25,0	AF5 018	42	15,35 €	32,0	AF6 018	32	21,00 €
22	18,0	AF4 022	60	11,90 €	25,0	AF5 022	36	16,30 €	33,5	AF6 022	28	22,35 €
25	18,0	AF4 025	56	13,95 €								
28	19,0	AF4 028	48	14,25 €	25,0	AF5 028	36	19,10 €	35,0	AF6 028	24	24,75 €
30	19,0	AF4 030	40	14,70 €								
35	19,5	AF4 035	36	16,50 €	27,0	AF5 035	24	20,95 €	35,0	AF6 035	18	28,75 €
42	20,5	AF4 042	32	18,60 €	27,0	AF5 042	22	26,25 €	36,5	AF6 042	16	35,75 €
45	20,5	AF4 045	28	20,65 €								
48	21,0	AF4 048	24	22,70 €	27,5	AF5 048	16	30,65 €	37,5	AF6 048	12	38,80 €
54	21,0	AF4 054	24	25,65 €	28,5	AF5 054	16	34,65 €	38,0	AF6 054	12	44,80 €
57	21,5	AF4 057	20	28,00 €					38,5	AF6 057	12	46,75 €
60	21,5	AF4 060	20	28,70 €	29,0	AF5 060	12	37,60 €	39,0	AF6 060	10	48,35 €
64	21,5	AF4 064	18	30,55 €	29,0	AF5 064	12	39,70 €	39,5	AF6 064	10	50,65 €
67	22,0	AF4 067	16	32,60 €	29,0	AF5 070	12	41,80 €	40,0	AF6 070	8	54,80 €
76	22,0	AF4 076	16	35,30 €	30,0	AF5 076	10	44,50 €	40,5	AF6 076	8	57,60 €
80	22,5	AF4 080	16	37,80 €								
89	22,5	AF4 089	12	39,15 €	30,5	AF5 089	8	49,40 €	41,5	AF6 089	6	63,80 €
102	23,0	AF4 102	10	51,15 €								
108	23,5	AF4 108	10	54,10 €	31,0	AF5 108	6	68,20 €	42,5	AF6 108	4	86,65 €
114	23,5	AF4 114	10	57,05 €	31,5	AF5 114	6	71,90 €	43,0	AF6 114	4	93,20 €
125	23,5	AF4 125	8	63,45 €								
133	24,0	AF4 133	6	65,90 €					44,0	AF6 133 **	4	108,90 €
140	24,5	AF4 140	6	69,80 €	32,0	AF5 140 **	6	88,00 €	44,5	AF6 140 **	4	115,65 €
160	25,0	AF4 160	6	80,00 €					45,0	AF6 160 **	4	134,85 €

** - dĺžka trubice 1m.



Syntetický kaučuk (elastomer) čiernej farby, pre teploty od -50°C(-200°C) do +110°C.
 Vysoko ohybný izolačný materiál so štruktúrou uzavretých buniek, vysokým odporom proti difúzii vodnej pary a nízkou tepelnou vodivosťou.
 Dĺžka samolepiacej trubice 2m. Faktor difúzneho odporu $\mu > 10\,000$. Súčiniteľ tepelnej vodivosti $\lambda 0\text{ }^\circ\text{C} = 0,033\text{ W/m.K}$.
 Trieda reakcie na oheň BL-s3, d0.

Vonk. Ø potr. (mm)	Armaflex AF1 (A)				Armaflex AF2 (A)				Armaflex AF3 (A)				Armaflex AF4 (A)			
	Hr. izolácie 7,5 mm až 10 mm				Hr. izolácie 11 mm až 16 mm				Hr. izolácie 13 mm až 19 mm				Hr. izolácie 16 mm až 25 mm			
	Hr. izol.	Obj. kód	bm/bal.	EUR/bm bez DPH	Hr. izol.	Obj. kód	bm/bal.	EUR/bm bez DPH	Hr. izol.	Obj. kód	bm/bal.	EUR/bm bez DPH	Hr. izol.	Obj. kód	bm/bal.	EUR/bm bez DPH
15	8,0	AF1 015 -A	192	4,85 €	11,5	AF2 015 -A	130	7,15 €	14,0	AF3 015 -A	108	10,85 €	17,0	AF4 015 -A	88	12,20 €
18	8,0	AF1 018 -A	140	5,20 €	11,5	AF2 018 -A	120	7,60 €	14,0	AF3 018 -A	96	11,25 €	17,5	AF4 018 -A	70	12,55 €
22	8,5	AF1 022 -A	132	5,70 €	12,0	AF2 022 -A	100	8,15 €	14,5	AF3 022 -A	84	12,45 €	18,0	AF4 022 -A	60	14,00 €
28	8,5	AF1 028 -A	100	6,20 €	12,5	AF2 028 -A	84	8,75 €	15,5	AF3 028 -A	64	14,30 €	19,0	AF4 028 -A	48	16,35 €
35	9,0	AF1 035 -A	76	6,80 €	13,0	AF2 035 -A	62	10,25 €	16,0	AF3 035 -A	46	16,40 €	19,5	AF4 035 -A	36	18,65 €
42	9,0	AF1 042 -A	60	7,65 €	13,5	AF2 042 -A	48	11,30 €	16,5	AF3 042 -A	40	18,30 €	20,5	AF4 042 -A	32	20,85 €
48	9,0	AF1 048 -A	50	8,65 €	13,5	AF2 048 -A	44	13,30 €	16,5	AF3 048 -A	32	21,85 €	21,0	AF4 048 -A	24	25,00 €
54	9,0	AF1 054 -A	48	9,90 €	13,5	AF2 054 -A	36	15,60 €	17,0	AF3 054 -A	28	24,70 €	21,0	AF4 054 -A	24	28,00 €
60	9,0	AF1 060 -A	36	12,05 €	14,0	AF2 060 -A	32	17,00 €	17,0	AF3 060 -A	24	27,40 €	21,5	AF4 060 -A	20	31,15 €
76	9,5	AF1 076 -A	28	15,50 €	14,0	AF2 076 -A	28	20,90 €	17,5	AF3 076 -A	16	33,45 €	22,0	AF4 076 -A	16	37,60 €
89	9,5	AF1 089 -A	22	18,45 €	14,5	AF2 089 -A	22	23,70 €	18,0	AF3 089 -A	16	37,50 €	22,5	AF4 089 -A	12	42,20 €

PÁSY AF ARMAFLEX

Pásy zo syntetického kaučuku.

AF Armaflex			
Hr. izol. (mm)	Rola (šírka 1m) Obj.kód	m ² / bal.	EUR/m2 bez DPH
3			
6			
10	AF 10MM -E	10	40,95 €
13	AF 13MM -E	8	48,55 €
16	AF 16MM -E	7	62,40 €
19	AF 19MM -E	6	75,05 €
25	AF 25MM -E	4	93,40 €
32	AF 32MM -E	3	116,50 €
50	AF 50MM -E	5	147,70 €

Samolepiace pásy zo syntetického kaučuku.

AF Armaflex (A) samolep			
Hr. izol. (mm)	Rola (šírka 1m) Obj.kód	m ² / bal.	EUR/m2 bez DPH
3	AF 03MM -EA	30	39,00 €
6	AF 06MM -EA	15	47,55 €
10	AF 10MM -EA	10	60,60 €
13	AF 13MM -EA	8	68,25 €
16	AF 16MM -EA	7	82,15 €
19	AF 19MM -EA	6	94,90 €
25	AF 25MM -EA	4	112,40 €
32	AF 32MM -EA	3	136,45 €

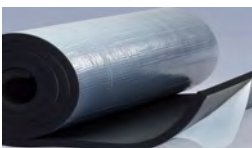
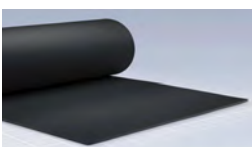



Chladové objímky. Závesné systémy pre rozvody chladu alebo klimatizácie bez tepelných mostov.

Vonk. Ø potrubia (mm)	Armafix FX 2					Armafix FX 4					Armafix FX 6				
	Hr. izolácie 11 mm až 16 mm					Hr. izolácie 16mm až 25 mm					Hr. izolácie 32 mm až 45mm				
	Vzdialenosť závesov (m)	Vonkajší Ø závesov	Obj. kód	ks/bal.	EUR/ks bez DPH	Vzdialenosť závesov (m)	Vonkajší Ø závesov	Obj. kód	ks/bal.	EUR/ks bez DPH	Vzdialenosť závesov (m)	Vonkajší Ø závesov	Obj. kód	ks/bal.	EUR/ks bez DPH
12	2	38	FX2 10/12	32	6,60 €	2	50	FX4(3) 10/12	28	7,35 €					
18	2,25	43	FX2 15/18	32	6,70 €	2,25	55	FX4(3) 15/18	28	7,50 €	2,25	77	FX6 15/18	20	10,05 €
22	2,75	47	FX2 22/25	32	7,55 €	2,75	60	FX4(3) 22/25	28	8,30 €	2,75	80	FX6 22/25	20	11,15 €
28	3	53	FX2 28/30	32	8,55 €	3	66	FX4(3) 28/30	28	9,70 €	3	91	FX6 28/30	20	12,75 €
35	3,5	61	FX2 35/38	28	9,25 €	3,5	74	FX4(3) 35/38	24	10,80 €	3,5	104	FX6 35/38	16	14,50 €
42	3,75	69	FX2 42/45	28	9,45 €	3,75	85	FX4(3) 42/45	24	10,90 €	3,75	113	FX6 42/45	16	15,25 €
48	4,25	76	FX2 48	28	9,90 €	4,25	91	FX4(3) 48	24	11,50 €	4,25	119	FX6 48	16	16,55 €
54	4,25	82	FX2 54/57	28	10,25 €	4,25	98	FX4(3) 54/57	24	12,15 €	4,25	126	FX6 54/57	16	17,40 €
60	4,75	89	FX2 60/64	24	12,75 €	4,75	105	FX4(3) 60/64	20	14,90 €	4,75	134	FX6 60/64	12	21,40 €
70	4,75	99	FX2 70	24	13,60 €	4,75	115	FX4(3) 70	20	15,75 €	4,75	140	FX6 70	12	23,15 €
76	5,5	105	FX2 76/80	20	13,95 €	5,5	122	FX4(3) 76/80	16	17,50 €	5,5	152	FX6 76/80	12	25,15 €
89	6	118	FX2 89	16	16,15 €	6	136	FX4(3) 89	12	20,85 €	6	167	FX6 89	12	29,85 €
108	6	141	FX2 102/108	16	19,20 €	6	156	FX4(3) 102/108	12	22,50 €	6	179	FX6 102/108	12	32,75 €
114	6	144	FX2 114	12	21,80 €	6	162	FX4(3) 114	12	25,50 €	6	188	FX6 102/108	12	38,85 €
125	6	158	FX2 125	12	22,85 €	6	173	FX4(3) 125	12	27,65 €	6	196	FX6 114	12	41,30 €
133	6	165	FX2 133/140	12	24,80 €	6	183	FX4(3) 133/140	12	29,90 €	6	219	FX6 133/140	8	47,00 €
160	6	193	FX2 160	9	27,70 €	6	210	FX4(3) 160	6	34,75 €	6	248	FX6 160	6	63,45 €
168	6	198	FX2 168	9	30,00 €	6	216	FX4(3) 165/168	6	37,70 €	6	254	FX6 165/168	5	66,85 €
200						6	255	FX4(3) 204	4	138,65 €	6	305	FX6 204	3	173,40 €
219						6	267	FX4(3) 216/219	4	65,25 €	6	317	FX6 216/219	1	134,25 €
254						6	305	FX4(3) 254	3	156,30 €	6	355	FX6 254	1	200,95 €
267						6	318	FX4(3) 267/273	3	88,65 €	6	368	FX6 267/273	1	165,85 €
306						6	357	FX4(3) 306	1	200,75 €	6	407	FX6 306	6	239,00 €
324						4,5	375	FX4(3) 324	1	213,20 €	4,5	425	FX6 324	6	261,60 €
356						4,2	407	FX4(3) 356	6	226,45 €	4,2	457	FX6 356	6	274,80 €
406						4,2	457	FX4(3) 406	6	247,85 €	4,2	507	FX6 406	2	304,40 €
457						3,7	508	FX4(3) 457	4	268,50 €	3,7	558	FX6 457	2	341,75 €
508						3,4	559	FX4(3) 508	4	302,50 €	3,4	609	FX6 508	2	379,90 €
610						2,9	661	FX4(3) 610	2	339,90 €	2,9	711	FX6 610	2	431,25 €

TRUBICE NH ARMAFLEX



Syntetický kaučuk (elastomer) šedej farby, pre teploty od -50°C do +110°C. Vysoko ohybný ekologický izolačný materiál so štruktúrou uzavretých buniek. Neobsahuje žiadne samozhášavé prísady na báze halogénov. V prípade požiaru dochádza k obmedzeniu vzniku toxických spodín a zníženiu hustoty dymu. Izolácia je vhodná pre použitie do čistých priestorov, serverovní, v námornom priemysle a pod. Faktor difúzneho odporu $\mu > 2000$. Súčiniteľ tepelnej vodivosti $\lambda 0^\circ\text{C} = 0,040 \text{ W/m.K}$. Dĺžka trubice 2m. Trieda reakcie na oheň D(L)-s2, d0.

Vonk. Ø potr. (mm)	NH Armaflex			NH Armaflex			NH Armaflex			NH Armaflex		
	Hr. izolácie 9 mm			Hr. izolácie 13 mm			Hr. izolácie 19 mm			Hr. izolácie 25 mm		
	Obj. kód	bm/ bal.	EUR/bm bez DPH	Obj. kód	bm/ bal.	EUR/bm bez DPH	Obj. kód	bm/ bal.	EUR/bm bez DPH	Obj. kód	bm/ bal.	EUR/bm bez DPH
10	010 / 9	192	5,70 €	010 / 13	140	7,80 €						
12	012 / 9	172	6,05 €	012 / 13	130	8,35 €						
15	015 / 9	144	6,35 €	015 / 13	112	9,35 €	015 / 19	64	16,95 €			
18	018 / 9	130	6,70 €	018 / 13	98	10,10 €	018 / 19	58	17,50 €			
22	022 / 9	108	7,45 €	022 / 13	84	10,95 €	022 / 19	50	20,30 €	022 / 25	36	39,90 €
28	028 / 9	82	8,40 €	028 / 13	64	11,85 €	028 / 19	48	23,80 €	028 / 25	32	46,85 €
35	035 / 9	60	9,40 €	035 / 13	50	14,40 €	035 / 19	32	27,55 €	035 / 25	24	54,80 €
42	042 / 9	50	10,75 €	042 / 13	40	16,15 €	042 / 19	24	31,15 €	042 / 25	20	61,65 €
48	048 / 9	42	12,45 €	048 / 13	32	19,40 €	048 / 19	22	37,95 €	048 / 25	16	71,50 €
54				054 / 13	32	23,25 €	054 / 19	18	42,90 €			
60				060 / 13	28	25,55 €	060 / 19	18	48,00 €	060 / 25	16	83,65 €
76				076 / 13	24	32,10 €	076 / 19	16	59,10 €	076 / 25	12	101,95 €
89				089 / 13	18	38,25 €	089 / 19	16	65,55 €	089 / 25	12	107,15 €

PÁSY NH ARMAFLEX



Pásy zo syntetického kaučuku.

NH Armaflex			
Hr. izol. (mm)	Rola (šírka 1m) Obj. kód	m ² / bal.	EUR/m ² bez DPH
6	NH 06 -99 -E	15	59,60 €
9	NH 09 -99 -E	10	91,00 €
13	NH 13 -99 -E	8	106,80 €
19	NH 19 -99 -E	6	165,05 €
25	NH 25 -99 -E	4	203,40 €

Samolepiace pásy zo syntetického kaučuku.

NH Armaflex (A) samolep			
Hr. izol. (mm)	Rola (šírka 1m) Obj. kód	m ² / bal.	EUR/m ² bez DPH
6	NH 06 -99 -EA	15	96,50 €
9	NH 09 -99 -EA	10	131,65 €
13	NH 13 -99 -EA	8	148,35 €
19	NH 19 -99 -EA	6	199,35 €
25	NH 25 -99 -EA	4	245,00 €

TRUBICE ARMAFLEX ACe Plus



Syntetický kaučuk (elastomer) čiernej farby, pre teploty od -50°C do +110°C. Vysoko ohybný izolačný materiál so štruktúrou uzavretých buniek, vysokým odporom proti difúzii vodnej pary a nízkou tepelnou vodivosťou.

Dĺžka trubice 2m. Faktor difúzneho odporu $\mu > 7000$ až 10 000. Súčiniteľ tepelnej vodivosti $\lambda_{0^\circ\text{C}} = 0,035 \text{ W/m.K}$. Trieda reakcie na oheň: trubice B(L)-s2, d0.

Vonk. Ø potr. (mm)	Armaflex Ace PLUS			Armaflex Ace PLUS			Armaflex Ace PLUS			Armaflex Ace PLUS		
	Hr. izolácie 6mm			Hr. izolácie 9 mm			Hr. izolácie 13 mm			Hr. izolácie 19 mm		
	Obj. kód	bm/ bal.	EUR/bm bez DPH	Obj. kód	bm/ bal.	EUR/bm bez DPH	Obj. kód	bm/ bal.	EUR/bm bez DPH	Obj. kód	bm/ bal.	EUR/bm bez DPH
6	006 / 6	568	1,25 €	006 / 9	362	1,40 €						
10	010 / 6	380	1,35 €	010 / 9	266	1,60 €	010 / 13	172	1,95 €			
12	012 / 6	330	1,45 €	012 / 9	234	1,65 €	012 / 13	162	2,30 €			
15	015 / 6	280	1,50 €	015 / 9	200	1,70 €	015 / 13	122	2,40 €	015 / 19	72	4,20 €
18	018 / 6	228	1,65 €	018 / 9	166	1,75 €	018 / 13	104	2,50 €	018 / 19	60	4,40 €
22	022 / 6	170	1,75 €	022 / 9	140	1,90 €	022 / 13	100	2,75 €	022 / 19	56	4,70 €
28	028 / 6	128	2,00 €	028 / 9	98	2,30 €	028 / 13	82	3,40 €	028 / 19	48	5,25 €
35	035 / 6	110	2,95 €	035 / 9	76	3,30 €	035 / 13	60	4,05 €	035 / 19	38	6,20 €
42				042 / 9	64	4,15 €	042 / 13	50	4,95 €	042 / 19	32	7,30 €
48				048 / 9	54	4,70 €	048 / 13	42	5,35 €	048 / 19	28	8,85 €
54				054 / 9	52	5,40 €	054 / 13	38	6,85 €	054 / 19	24	9,05 €
60				060 / 9	48	6,55 €	060 / 13	32	7,40 €	060 / 19	24	9,55 €
64				064 / 9	44	9,10 €	064 / 13	30	7,80 €	064 / 19	20	10,90 €
76				076 / 9	32	10,00 €	076 / 13	28	8,05 €	076 / 19	18	12,10 €
89				089 / 9	28	10,30 €	089 / 13	20	12,60 €	089 / 19	16	14,90 €
108				108 / 9	26	12,50 €	108 / 13	20	16,25 €	108 / 19	16	23,05 €
114				114 / 9	24	13,10 €	114 / 13	20	16,75 €	114 / 19	14	24,20 €
133							133 / 13	16	19,05 €	133 / 19	10	25,95 €
140							140 / 13	12	19,75 €	140 / 19	10	30,55 €
160							160 / 13	12	20,50 €	160 / 19	10	35,00 €

TRUBICE ARMAFLEX ACe Plus



Syntetický kaučuk (elastomer) čiernej farby, pre teploty od -50°C do +110°C. Vysoko ohybný izolačný materiál so štruktúrou uzavretých buniek, vysokým odporom proti difúzii vodnej pary a nízkou tepelnou vodivosťou.

Dĺžka trubice 2m. Faktor difúzneho odporu $\mu > 7000$ až 10 000. Súčiniteľ tepelnej vodivosti $\lambda 0^\circ\text{C} = 0,035 \text{ W/m.K}$. Trieda reakcie na oheň: trubice B(L)-s2, d0.

Vonk Ø potr (mm)	Armaflex Ace PLUS			Armaflex Ace PLUS			Armaflex Ace PLUS		
	Hr. izolácie 25 mm			Hr. izolácie 32 mm			Hr. izolácie 40mm		
	Obj. kód	bm / bal.	EUR / bm bez DPH	Obj. kód	bm / bal.	EUR / bm bez DPH	Obj. kód	bm / bal.	EUR / bm bez DPH
22	022 / 25	40	9,35 €						
28	028 / 25	36	10,15 €	028 / 32	24	16,60 €			
35	035 / 25	24	11,60 €	035 / 32	18	18,20 €			
42	042 / 25	24	12,60 €	042 / 32	18	19,95 €	042 / 40	12	43,20 €
48	048 / 25	20	13,45 €	048 / 32	18	20,90 €	048 / 40	12	44,85 €
54	054 / 25	18	13,85 €	054 / 32	12	23,05 €	054 / 40	10	46,75 €
60	060 / 25	18	16,75 €	060 / 32	10	31,50 €	060 / 40	10	48,75 €
64	064 / 25	16	26,05 €	064 / 32	10	32,90 €	064 / 40	10	50,80 €
76	076 / 25	12	26,90 €	076 / 32	10	34,40 €	076 / 40	8	53,65 €
89	089 / 25	12	28,00 €	089 / 32	10	37,25 €	089 / 40	6	57,85 €
108	108 / 25	8	32,00 €				108 / 40	4	66,50 €
114	114 / 25	10	33,80 €	114 / 32	8	50,10 €	114 / 40	6	68,50 €
140	140 / 25	4	50,60 €	140 / 32	6	56,60 €	140 / 40	4	73,90 €
160				160 / 32	4	62,90 €			
168							168 / 40	4	82,90 €

PÁSY ARMAFLEX ACe



Syntetický kaučuk (elastomer) čiernej farby, pre teploty od -50°C do +110°C. Vysoko ohybný izolačný materiál so štruktúrou uzavretých buniek, vysokým odporom proti difúzii vodnej pary a nízkou tepelnou vodivosťou.

Faktor difúzneho odporu $\mu > 7000$ až 10 000. Súčiniteľ tepelnej vodivosti $\lambda 0^\circ\text{C} = 0,036$ až $0,038 \text{ W/m.K}$. Trieda reakcie na oheň B-s3, d0.

Izolačné pásy zo syntetického kaučuku.

Armaflex Ace			
Hr. izol. (mm)	Rola (šírka 1m) Obj.kód	m ² / bal.	EUR/m ² bez DPH
6	ACe 06 -99 -E	30	12,60 €
9	ACe 09 -99 -E	22	16,05 €
13	ACe 13 -99 -E	18	19,00 €
19	ACe 19 -99 -E	14	26,35 €
25	ACe 25 -99 -E	9	38,10 €
32	ACe 32 -99 -E	7	48,85 €
40	ACe 40 -99 -E	6	67,85 €
50	ACe 50 -99 -E	4	83,90 €

Samolepiace pásy zo syntetického kaučuku

Armaflex ACe (A) samolep			
Hr izol (mm)	Rola (šírka 1m) Obj.kód	m ² / bal.	EUR/m ² bez DPH
6	ACe 06 -99 -EA	30	19,80 €
9	ACe 09 -99 -EA	22	23,20 €
13	ACe 13 -99 -EA	18	26,35 €
19	ACe 19 -99 -EA	14	33,90 €
25	ACe 25 -99 -EA	9	45,55 €
32	ACe 32 -99 -EA	7	57,85 €
40	ACe 40 -99 -EA	6	74,95 €
50	ACe 50 -99 -EA	4	91,95 €

PÁSY ARMAFLEX DUCT



Plošná izolácia typu Armaflex ACe s hliníkovou fóliou vystuženou sklotextilnou mriežkou (ALS). Pásky sú vhodné k izolovaniu vzduchotechnických zariadení a potrubí v interiéri. Súčiniteľ tepelnej vodivosti $\lambda_{0^{\circ}\text{C}} = 0,036 \text{ W/m.K}$. Trieda reakcie na oheň E.

Samolepiace pásky zo syntetického kaučuku s povrchom ALS.

Armaflex DUCT AL (A) samolep			
<i>Hr. izol. (mm)</i>	<i>Rola (šírka 1m) Obj. kód</i>	<i>m²/ bal.</i>	<i>EUR/m² bez DPH</i>
9	DUCT AL 09 -EA	20	15,30 €
13	DUCT AL 13 -EA	16	18,30 €
19	DUCT AL 19 -EA	12	23,50 €
25	DUCT AL 25 -EA	8	30,00 €
32	DUCT AL 32 -EA	6	38,40 €

TRUBICE Arma-Chek SILVER

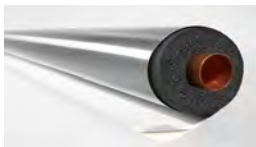

Trvalý a estetický systém ochrany izolácií. Izolačné trubice Armaflex s povrchom ARMA-CHEK SILVER (s lesklou pokovenou povrchovou úpravou). Povrch nahrádza oplechovanie, je odolný voči UV žiareniu, poveternostným vplyvom, vyznačuje sa vysokou pevnosťou a odolnosťou voči mechanickému poškodeniu. Teplotná odolnosť od -50°C do +110°C.

Dĺžka trubice 1m. Faktor difúzneho odporu $\mu > 15\ 000$. Súčiniteľ tep. vodivosti $\lambda\ 0\ ^\circ\text{C} = 0,036\ \text{W/m.K}$. Trieda reakcie na oheň E.

Vonk. Ø potr. (mm)	Arma-Chek SILVER			Arma-Chek SILVER			Arma-Chek SILVER			Arma-Chek SILVER		
	Hr. izolácie 13 mm			Hr. izolácie 19 mm			Hr. izolácie 25 mm			Hr. izolácie 32 mm		
	Obj. kód	bm / bal.	EUR /bm bez DPH	Obj. kód	bm / bal.	EUR /bm bez DPH	Obj. kód	bm / bal.	EUR /bm bez DPH	Obj. kód	bm / bal.	EUR /bm bez DPH
15	015 / 13	61		015 / 19	39							
18	018 / 13	52		018 / 19	36							
22	022 / 13	50		022 / 19	32		022 / 25	20		022 / 32	12	
28	028 / 13	41		028 / 19	24		028 / 25	18		028 / 32	12	
35	035 / 13	30		035 / 19	18		035 / 25	12		035 / 32	9	
42	042 / 13	25		042 / 19	16		042 / 25	11		042 / 32	8	
48	048 / 13	21		048 / 19	14		048 / 25	9		048 / 32	6	
54	054 / 13	19		054 / 19	12		054 / 25	9		054 / 32	6	
60	060 / 13	16		060 / 19	12		060 / 25	9		060 / 32	5	
64	064 / 13	15		064 / 19	10		064 / 25	6		064 / 32	5	
76	076 / 13	14		076 / 19	9		076 / 25	6		076 / 32	5	
89	089 / 13	9		089 / 19	8		089 / 25	5		089 / 32	5	
114	114 / 13	9		114 / 19	7		114 / 25	3		114 / 32	2	
125	125 / 13	9		125 / 19	5							
133	133 / 13	8		133 / 19	5		133 / 25	2				
140	140 / 13	6		140 / 19	5		140 / 25	2		140 / 32	2	
160	160 / 13	6		160 / 19	5					160 / 32	1	

PÁSY Arma-Chek SILVER



Samolepiace pásy zo syntetického kaučuku.

Arma-Chek SILVER (A) samolep			
Hr. izol. (mm)	Rola (šírka 1m) Obj. kód	m ² / bal.	EUR/m ² bez DPH
13	SI 13 -99 -EA	8	41,40 €
19	SI 19 -99 -EA	6	46,00 €
25	SI 25 -99 -EA	4	50,95 €
32	SI 32 -99 -EA	3	66,40 €
40	SI 40 -99 -EA	7	99,60 €
50	SI 50 -99 -EA	5	116,45 €

TRUBICE HT ARMAFLEX

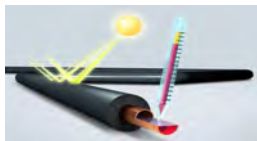

Ohybný izolačný elastomerový materiál na báze EPDM. Izolácia čiernej farby s mimoriadnou odolnosťou proti UV žiareniu a vysokým teplotám. Izolácia sa používa prevažne na izolovanie rozvodov solárnych aplikácií vo vonkajšom prostredí. Rozsah použitia od -50°C do +175°C (stála prevádzková teplota do +150°C). Lepiť len lepidlom HT 625. Dĺžka trubice 2m. Faktor dif. odporu $\mu > 4000$, súčiniteľ tepelnej vodivosti $\lambda_{0^\circ\text{C}} = 0,040 \text{ W/m.K}$. Trieda reakcie na oheň D-s3, d0.

Vonk. Ø potr. (mm)	HT Armaflex			HT Armaflex			HT Armaflex			HT Armaflex		
	Hr. izolácie 10mm			Hr. izolácie 13 mm			Hr. izolácie 19 mm			Hr. izolácie 25 mm		
	Obj. kód	bm/ bal.	EUR/bm bez DPH	Obj. kód	bm/ bal.	EUR/bm bez DPH	Obj. kód	bm/ bal.	EUR/bm bez DPH	Obj. kód	bm/ bal.	EUR/bm bez DPH
10	010 / 10	192	4,40 €	010 / 13	140	6,00 €						
12	012 / 10	172	4,70 €	012 / 13	130	6,40 €						
15	015 / 10	144	4,80 €	015 / 13	112	7,20 €	015 / 19	64	13,05 €	015 / 25	40	20,20 €
18	018 / 10	130	5,20 €	018 / 13	98	7,80 €	018 / 19	58	13,45 €	018 / 25	36	20,50 €
22	022 / 10	108	5,75 €	022 / 13	84	8,45 €	022 / 19	50	15,45 €	022 / 25	36	22,15 €
28	028 / 10	82	6,55 €	028 / 13	64	9,15 €	028 / 19	48	18,50 €	028 / 25	32	27,70 €
35	035 / 10	60	7,25 €	035 / 13	50	11,20 €	035 / 19	32	21,20 €	035 / 25	24	29,20 €
42	042 / 10	50	8,25 €	042 / 13	40	12,45 €	042 / 19	24	23,95 €	042 / 25	20	35,30 €
48				048 / 13	32	14,90 €	048 / 19	22	29,25 €	048 / 25	16	39,70 €
54				054 / 13	32	17,75 €	054 / 19	18	33,05 €	054 / 25	16	45,20 €
60				060 / 13	28	19,70 €	060 / 19	16	37,35 €	060 / 25	16	49,25 €
76				076 / 13	24	24,75 €	076 / 19	18	45,40 €	076 / 25	12	60,00 €
89				089 / 13	18	29,45 €	089 / 19	16	50,40 €	089 / 25	12	66,10 €

NEKONEČNÉ TRUBICE HT ARMAFLEX



Vonk. Ø potr. (mm)	HT Armaflex			HT Armaflex		
	Hr. izolácie 13 mm			Hr. izolácie 19 mm		
	Obj. kód	bm/ bal.	EUR / bm bez DPH	Obj. kód	bm/ bal.	EUR / bm bez DPH
15	015 / 13 -E	26	7,20 €	015 / 19 -E	16	13,05 €
18	018 / 13 -E	22	7,80 €	018 / 19 -E	14	13,45 €
22	022 / 13 -E	18	8,45 €	022 / 19 -E	12	15,45 €

PÁSY HT ARMAFLEX

Izolačné pásy zo syntetického kaučuku.

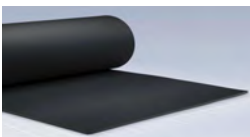

HT Armaflex			
Hr. izol. (mm)	Rola (šírka 1m) Obj. kód	m ² / bal.	EUR/m2 bez DPH
10	HT 10 -99 -E	10	68,30 €
13	HT 13 -99 -E	8	80,95 €
19	HT 19 -99 -E	6	125,10 €
25	HT 25 -99 -E	4	168,85 €

TRUBICE HT ARMAFLEX S (SWH/SBK)

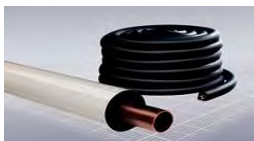

Materiál na báze penového syntetického elastomeru typu EPDM s pevnou UV odolnou bielou (SWH) alebo čiernou (SBK) PE povrchovou úpravou.

Rozsah použitia od -50°C do +175°C (stála prevádzková teplota do +150°C). Lepiť len lepidlom HT 625. Dĺžka trubice 2m.

Vonk. Ø potr. (mm)	HT Armaflex SWH			HT Armaflex SWH			HT Armaflex SWH		
	Hr. izolácie 13 mm			Hr. izolácie 20 mm			Hr. izolácie 32 mm		
	Obj. kód	bm / bal.	EUR /bm bez DPH	Obj. kód	bm / bal.	EUR /bm bez DPH	Obj. kód	bm / bal.	EUR /bm bez DPH
12	012 / 13 -SWH	130	7,95 €	012 / 20 -SWH	70	3,30 €			
15	015 / 13 -SWH	112	1,80 €	015 / 20 -SWH	64	3,30 €	015 / 32 -SWH	36	5,05 €
18	018 / 13 -SWH	98	1,95 €	018 / 20 -SWH	58	3,40 €	018 / 32 -SWH	30	5,15 €
22	022 / 13 -SWH	84	2,15 €	022 / 20 -SWH	50	3,90 €	022 / 32 -SWH	28	5,55 €
28	028 / 13 -SWH	64	2,30 €	028 / 20 -SWH	40	4,65 €	028 / 32 -SWH	24	6,95 €
35				035 / 20 -SWH	32	5,30 €	035 / 32 -SWH	22	7,30 €
42				042 / 20 -SWH	24	6,00 €	042 / 32 -SWH	18	8,85 €

Vonk. Ø potr. (mm)	HT Armaflex SBK			HT Armaflex SBK			HT Armaflex SBK		
	Hr. izolácie 13 mm			Hr. izolácie 20 mm			Hr. izolácie 32 mm		
	Obj. kód	bm / bal.	EUR /bm bez DPH	Obj. kód	bm / bal.	EUR /bm bez DPH	Obj. kód	bm / bal.	EUR /bm bez DPH
15	015 / 13 -SBK	112	1,80 €	015 / 20 -SBK	64	3,30 €			
18	018 / 13 -SBK	98	1,95 €	018 / 20 -SBK	58	3,40 €	018 / 32 -SBK	30	5,15 €
22	022 / 13 -SBK	84	2,15 €	022 / 20 -SBK	50	3,90 €	022 / 32 -SBK	28	5,55 €
28	028 / 13 -SBK	64	2,30 €	028 / 20 -SBK	40	4,65 €	028 / 32 -SBK	24	6,95 €
35				035 / 20 -SBK	32	5,30 €	035 / 32 -SBK	22	7,30 €
42				042 / 20 -SBK	24	6,00 €	042 / 32 -SBK	18	8,85 €

Kovové objímky (dvojskrutkové) 2S M8/M10



Kov. objímka 2S M8/M10						
Vhodné pre izolačné závesy:				Obj. kód	ks/ bal.	EUR/ks bez DPH
13 mm	19 mm	25 mm	32 mm			
9, 10, 12				Ø 31-37	50	0,55 €
15, 18				Ø 38-46	50	0,65 €
22	10, 12			Ø 47-52	50	0,65 €
28, 35	15, 18, 22			Ø 53-61	50	0,70 €
		15		Ø 62-67	50	0,80 €
42, 48	28, 35	18, 22		Ø 68-74	50	0,95 €
54	42	28	15	Ø 75-81	50	1,10 €
60	48	35	18, 22	Ø 82-87	50	1,15 €
64	54	42	28	Ø 88-95	50	1,40 €
76	60, 64	48	35	Ø 96-103	50	1,45 €
		54, 60	42, 48	Ø 104-112	25	1,60 €
89	76	64	54	Ø 113-118	25	1,80 €
	89	76	60	Ø 119-127	25	1,95 €
108			64	Ø 128-137	25	2,20 €
114		89	76	Ø 138-144	25	2,30 €
	108		89	Ø 145-153	25	2,50 €
133	114	108		Ø 154-162	25	2,55 €
140		114		Ø 163-172	25	2,90 €
	133, 140		108, 114	Ø 173-183	15	3,20 €
160		133, 140		Ø 184-194	15	3,20 €
168	160		133	Ø 195-205	15	3,40 €
	168	160	140	Ø 206-216	15	3,55 €
		168	160	Ø 217-225	15	4,35 €

ZÁVESY RF s kovovou objímkou



Izolačné závesy pre chladiacu a klimatizačnú techniku.

Kovová objímka do priemeru 108mm má vnútorný závit M8/M10.

Izolačný záves slúži ku kompletnému odizolovaniu chladového systému.

Vonk. Ø potr. (mm)	RF s kov. objímkou						RF s kov. objímkou				
	Hr. izolácie 13 mm						Hr. izolácie 19 mm				
	Vzdialen ost' závesov (m)	Vonkajší Ø závesov (mm)	Obj. kód	ks/ bal.	EUR/ks bez DPH	Vzdialen ost' závesov (m)	Vonkajší Ø závesov (mm)	Obj. kód	ks/ bal.	EUR/ks bez DPH	
22	2,75	48	022 / 13	20	4,60 €	2,75	60	022 / 19	20	5,00 €	
28	3	54	028 / 13	20	5,05 €	3	66	028 / 19	20	5,40 €	
35	3,5	61	035 / 13	20	5,45 €	3,5	73	035 / 19	20	6,25 €	
42	3,75	68	042 / 13	20	5,55 €	3,75	80	042 / 19	20	6,35 €	
48	4,25	74	048 / 13	20	5,80 €	4,25	86	048 / 19	20	6,60 €	
54	4,25	80	054 / 13	20	5,90 €	4,25	92	054 / 19	20	6,95 €	
60	4,75	86	060 / 13	20	7,20 €	4,75	98	060 / 19	20	8,45 €	
64	4,75	90	064 / 13	20	7,25 €	4,75	102	064 / 19	20	8,45 €	
76	5,5	102	076 / 13	20	8,00 €	5,5	114	076 / 19	20	9,80 €	
89	6	115	089 / 13	20	9,15 €	6	127	089 / 19	20	11,55 €	
108	6	136	108 / 13	20	10,20 €	6	148	108 / 19	20	13,50 €	



Izolačné závesy pre chladiacu a klimatizačnú techniku. Chladová objímka (nosník trubiek) slúži ku kompletnému odizolovaniu chladového systému. Vysoká ochrana proti tepelným mostom.

Vonk. Ø potr. (mm)	Kaiflex RT ST					Kaiflex RT ST					Kaiflex RT ST					Kaiflex RT ST				
	Hr. izolácie 13 mm					Hr. izolácie 19 mm					Hr. izolácie 25 mm					Hr. izolácie 32 mm				
	Vzdialen ost'	Vonkajší Ø	Obj. kód	ks/bal.	EUR/ks bez DPH	Vzdialen ost'	Vonkajší Ø	Obj. kód	ks/bal.	EUR/ks bez DPH	Vzdialen ost'	Vonkajší Ø	Obj. kód	ks/bal.	EUR/ks bez DPH	Vzdialen ost'	Vonkajší Ø	Obj. kód	ks/bal.	EUR/ks bez DPH
10	2	36	010 / 13	52	2,50 €	2	48	010 / 19	32	3,05 €										
12	2	38	012 / 13	48	2,65 €	2	50	012 / 19	28	3,10 €	2	62	012 / 25	28	3,55 €					
15	2	41	015 / 13	40	2,75 €	2	53	015 / 19	22	3,20 €	2	65	015 / 25	24	3,70 €	2	79	015 / 32		3,90 €
18	2,25	44	018 / 13	32	2,75 €	2,25	56	018 / 19	20	3,30 €	2,25	68	018 / 25	24	3,80 €	2,25	82	018 / 32	28	4,15 €
22	2,75	48	022 / 13	32	3,15 €	2,75	60	022 / 19	32	3,40 €	2,75	72	022 / 25	38	4,15 €	2,75	86	022 / 32	24	4,50 €
28	3	54	028 / 13	40	3,50 €	3	66	028 / 19	24	4,00 €	3	78	028 / 25	32	4,80 €	3	92	028 / 32	24	5,10 €
35	3,5	61	035 / 13	30	3,80 €	3,5	73	035 / 19	38	4,40 €	3,5	85	035 / 25	26	5,35 €	3,5	99	035 / 32	18	5,85 €
42	3,75	68	042 / 13	46	3,85 €	3,75	80	042 / 19	32	4,65 €	3,75	92	042 / 25	22	5,75 €	3,75	106	042 / 32	40	6,35 €
48	4,25	74	048 / 13	34	4,05 €	4,25	86	048 / 19	28	4,75 €	4,25	98	048 / 25	40	6,00 €	4,25	112	048 / 32	30	6,65 €
54	4,25	80	054 / 13	32	4,20 €	4,25	92	054 / 19	48	4,90 €	4,25	104	054 / 25	40	6,55 €	4,25	118	054 / 32	30	7,15 €
57	4,25	83	057 / 13	28	4,45 €	4,25	95	057 / 19	48	5,15 €										
60	4,75	86	060 / 13	56	4,65 €	4,75	98	060 / 19	44	5,40 €	4,75	110	060 / 25	36	7,65 €	4,75	124	060 / 32	26	8,60 €
64	4,75	90	064 / 13	48	5,15 €	5	102	064 / 19	40	6,05 €	5	114	064 / 25	30	7,70 €	5	128	064 / 32	24	9,10 €
70	4,75	96	070 / 13	44	5,65 €	5	108	070 / 19	32	6,60 €						5	134	070 / 32	22	9,65 €
76	5,5	102	076 / 13	40	6,50 €	5,5	114	076 / 19	30	7,00 €	5,5	126	076 / 25	24	9,05 €	5,5	140	076 / 32	22	10,10 €
80	6	106	080 / 13	36	6,85 €	6	118	080 / 19	28	8,20 €										
89	6	115	089 / 13	30	6,85 €	6	127	089 / 19	26	8,35 €	6	139	089 / 25	22	10,70 €	6	153	089 / 32	16	12,00 €
108	6	136	108 / 13	22	8,00 €	6	148	108 / 19	18	9,70 €	6	160	108 / 25	16	11,65 €	6	174	108 / 32	12	14,35 €
114	6	142	114 / 13	18	9,25 €	6	154	114 / 19	16	10,25 €	6	166	114 / 25	12	16,90 €	6	180	114 / 32	12	15,60 €
125		153				6	165	125 / 19	12	12,40 €										
133	6	161	133 / 13	14	12,60 €	6	173	133 / 19	12	12,65 €						6	199	133 / 32	8	18,85 €
140	6	168	140 / 13	14	13,45 €	6	180	140 / 19	12	13,90 €	6	192	140 / 25	12	17,30 €	6	206	140 / 32	8	19,80 €
160	6	188	160 / 13	12	14,55 €	6	200	160 / 19	8	16,15 €	6	212	160 / 25	8	19,70 €	6	226	160 / 32	6	20,55 €
168	6	196	168 / 13	12	15,30 €	6	208	168 / 19	8	17,20 €	6	220	168 / 25	6	19,85 €	6	234	168 / 32	6	24,60 €
219	6	247	219 / 13	4	17,40 €	6	259	219 / 19	4	22,10 €	6	271	219 / 25	4	30,15 €	6	285	219 / 32	4	37,70 €

TRUBICE KAIFLEX ST s2



Vysoko ohybný izolačný mat. so štruktúrou uzavretých buniek (Flexible Elastomeric Foam- FEF).
Izolácia čiernej farby s vysokým odporom proti difúzii vodnej pary a nízkou tepelnou vodivosťou pre teploty od -50°C do +110°C. Dĺžka 2m. Faktor difúzneho odporu $\mu > 10000$. Súčiniteľ tep. vodivosti $\lambda_{0^\circ\text{C}} = 0,034 \text{ W/m.K}$. Trieda reakcie na oheň B-s2, d0.

Vonk. Ø potr. (mm)	Kaiflex ST s2			Kaiflex ST s2			Kaiflex ST s2			Kaiflex ST s2			Kaiflex ST s2		
	Hr. izolácie 9 mm			Hr. izolácie 13 mm			Hr. izolácie 19 mm			Hr. izolácie 25 mm			Hr. izolácie 32 mm		
	Obj. kód	bm/ bal.	EUR/bm bez DPH	Obj. kód	bm/ bal.	EUR/bm bez DPH	Obj. kód	bm/ bal.	EUR/bm bez DPH	Obj. kód	bm/ bal.	EUR/bm bez DPH	Obj. kód	bm/ bal.	EUR/bm bez DPH
6	006 / 9	360	1,20 €	006 / 13	240	1,60 €									
8	008 / 9	340	1,25 €	008 / 13	210	0,00 €									
10	010 / 9	320	1,30 €	010 / 13	190	1,95 €	010 / 19	106	3,20 €	010 / 25	72	5,70 €	010 / 32	40	9,30 €
12	012 / 9	280	1,40 €	012 / 13	172	2,00 €	012 / 19	100	3,30 €	012 / 25	60	6,15 €	012 / 32	36	9,50 €
15	015 / 9	240	1,45 €	015 / 13	154	2,20 €	015 / 19	86	3,95 €	015 / 25	60	5,90 €	015 / 32	32	9,90 €
18	018 / 9	190	1,45 €	018 / 13	130	2,35 €	018 / 19	78	4,15 €	018 / 25	50	6,05 €	018 / 32	32	10,30 €
22	022 / 9	156	1,75 €	022 / 13	110	2,55 €	022 / 19	74	4,70 €	022 / 25	42	6,75 €	022 / 32	32	10,85 €
28	028 / 9	124	1,95 €	028 / 13	86	2,70 €	028 / 19	58	5,65 €	028 / 25	40	7,10 €	028 / 32	24	11,40 €
35	035 / 9	92	2,15 €	035 / 13	76	3,30 €	035 / 19	48	6,45 €	035 / 25	32	7,80 €	035 / 32	24	11,60 €
42	042 / 9	70	2,40 €	042 / 13	56	3,70 €	042 / 19	40	7,30 €	042 / 25	24	9,75 €	042 / 32	24	13,95 €
48	048 / 9	60	2,85 €	048 / 13	48	4,55 €	048 / 19	30	9,05 €	048 / 25	24	11,35 €	048 / 32	18	15,05 €
54	054 / 9	60	3,30 €	054 / 13	46	5,40 €	054 / 19	30	10,05 €	054 / 25	22	12,85 €	054 / 32	18	17,45 €
60	060 / 9	60	4,15 €	060 / 13	40	5,90 €	060 / 19	28	11,15 €	060 / 25	22	13,90 €	060 / 32	16	18,80 €
64	064 / 9	54	4,60 €	064 / 13	40	6,10 €	064 / 19	28	11,95 €	064 / 25	18	14,85 €	064 / 32	16	19,70 €
70				070 / 13	40	6,85 €	070 / 19	28	12,70 €	070 / 25	18	16,95 €	070 / 32	14	21,30 €
76	076 / 9	54	5,50 €	076 / 13	34	7,45 €	076 / 19	28	13,75 €	076 / 25	18	16,60 €	076 / 32	12	22,45 €
80				080 / 13	30	8,15 €	080 / 19	26	14,80 €				080 / 32	12	23,80 €
89	089 / 9	36	6,65 €	089 / 13	30	8,80 €	089 / 19	22	15,30 €	089 / 25	14	18,35 €	089 / 32	10	24,80 €
108	108 / 9	28	10,45 €	108 / 13	28	12,55 €	108 / 19	20	21,10 €	108 / 25	10	25,10 €	108 / 32	8	34,30 €
114	114 / 9	28	11,15 €	114 / 13	28	13,80 €	114 / 19	18	22,25 €	114 / 25	10	26,65 €	114 / 32	8	36,25 €
125	125 / 9	20	13,00 €	125 / 13	20	17,90 €	125 / 19	18	24,65 €						
133	133 / 9	16	15,35 €	133 / 13	18	18,70 €	133 / 19	12	25,75 €				133 / 32	6	42,60 €
140	140 / 9	16	15,95 €	140 / 13	18	19,25 €	140 / 19	10	27,25 €	140 / 25	6	35,55 €	140 / 32	6	45,00 €
160				160 / 13	16	22,40 €	160 / 19	8	31,20 €				160 / 32	4	52,45 €
168							168 / 19	8	32,60 €	168 / 25	6	53,60 €	168 / 32	4	67,00 €

TRUBICE KAIFLEX ST

Vonk. Ø potr. (mm)	Kaiflex ST s2			Kaiflex ST s2		
	Hr. izolácie 40 mm			Hr. izolácie 50 mm		
	Obj. kód	bm/ bal.	EUR/bm bez DPH	Obj. kód	bm/ bal.	EUR/bm bez DPH
22	022 / 40	22	27,75 €	022 / 50	14	52,45 €
28	028 / 40	16	30,25 €	028 / 50	10	54,55 €
35	035 / 40	16	32,55 €	035 / 50	8	58,05 €
42	042 / 40	16	34,90 €	042 / 50	8	63,15 €
48	048 / 40	12	39,05 €	048 / 50	8	63,85 €
54	054 / 40	10	41,35 €	054 / 50	8	67,45 €
60	060 / 40	10	42,40 €	060 / 50	8	67,60 €
64	064 / 40	10	43,80 €	064 / 50	6	71,85 €
76	076 / 40	10	50,20 €	076 / 50	6	72,50 €
89	089 / 40	10	52,95 €	089 / 50	6	78,65 €
114	114 / 40	6	57,05 €	114 / 50	4	107,55 €
140	140 / 40	6	62,80 €	140 / 50	2	126,15 €
160	160 / 40	4	87,20 €	160 / 50	2	151,85 €
168	168 / 40	4	100,15 €			

PÁSY KAIFLEX ST



Vysoko ohybný izolačný mat. so štruktúrou uzavretých buniek (Flexible Elastomeric Foam- FEF).

Izolácia čiernej farby s vysokým odporom proti difúzii vodnej pary a nízkou tepelnou vodivosťou pre teploty od -50°C do +110°C. Šírka 1m. Faktor difúzneho odporu $\mu > 10000$. Súčiniteľ tep. vodivosti $\lambda_{0^\circ\text{C}} = 0,034 \text{ W/m.K}$. Trieda reakcie na oheň B-s3, d0.

Izolačné pásy zo syntetického kaučuku.

Kaiflex ST			
Hr. izol. (mm)	Rola (šírka 1m) Obj. kód	m ² / bal.	EUR/m ² bez DPH
6	ST 06	30	11,15 €
10	ST 10	20 (10)	16,55 €
13	ST 13	14 (8)	19,30 €
16	ST 16	12	24,90 €
19	ST 19	10 (6)	29,75 €
25	ST 25	8 (4)	36,60 €
32	ST 32	6 (3)	46,05 €
40	ST 40	5,5	62,30 €
50	ST 50	4	83,85 €

Samolepiace pásy zo syntetického kaučuku.

Kaiflex ST (SA)			
Hr. izol. (mm)	Rola (šírka 1m) Obj. kód	m ² / bal.	EUR/m ² bez DPH
6	ST 06 -SA	30	20,05 €
10	ST 10 -SA	20 (10)	25,00 €
13	ST 13 -SA	14 (8)	30,10 €
16	ST 16 -SA	12	33,30 €
19	ST 19 -SA	10 (6)	38,75 €
25	ST 25 -SA	8 (4)	45,70 €
32	ST 32 -SA	6 (3)	55,40 €
40	ST 40 -SA	5,5	71,65 €
50	ST 50 -SA	4	93,20 €

NOVINKA! Obmedzený vývin dymu,
vďaka triede stavebného materiálu B_L-s2, d0

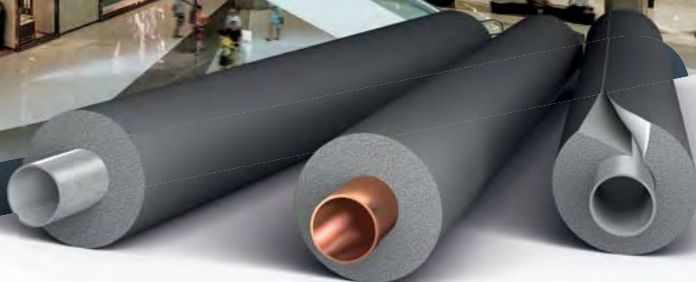

Kaiflex® ST s2

Všestranné využitie. Optimálna istota v prípade vzniku požiaru.

- Univerzálny izolačný materiál pre vysoko frekventované verejné a komerčné budovy.
- Spoľahlivá bezpečnosť: požiarne trieda stavebného materiálu B_L-s2, d0
- Splňuje náročné medzinárodne požiadavky na elastomerové izolačné materiály
- Spoľahlivo zabraňuje kondenzácii a znižuje riziko korózie pod izoláciou
- Dodatočná ochrana proti mikroorganizmom a plesniam

TRUBICE KAIFLEX ST endless

"Nekonečné" hadice Kaiflex ST.



Vonk. Ø potr. (mm)	Kaiflex ST endless			Kaiflex ST endless			Kaiflex ST endless		
	Hr. izolácie 6 mm			Hr. izolácie 9 mm			Hr. izolácie 13 mm		
	Obj. kód	bm/ bal.	EUR/bm bez DPH	Obj. kód	bm/ bal.	EUR/bm bez DPH	Obj. kód	bm/ bal.	EUR/bm bez DPH
6	006 / 6 -E	50	1,05 €	006 / 9 -E	40	1,20 €	006 / 13 -E	26	1,60 €
8	008 / 6 -E	48	1,15 €	008 / 9 -E	37	1,25 €	008 / 13 -E	26	-
10	010 / 6 -E	46	1,15 €	010 / 9 -E	34	1,30 €	010 / 13 -E	23	1,95 €
12	012 / 6 -E	40	1,20 €	012 / 9 -E	31	1,40 €	012 / 13 -E	18	2,00 €
15	015 / 6 -E	38	1,30 €	015 / 9 -E	27	1,45 €	015 / 13 -E	17	2,20 €
18	018 / 6 -E	30	1,40 €	018 / 9 -E	23	1,45 €	018 / 13 -E	15	2,35 €
22	022 / 6 -E	23	1,45 €	022 / 9 -E	19	1,75 €	022 / 13 -E	14	2,55 €
28	028 / 6 -E	20	1,65 €	028 / 9 -E	14	1,95 €	028 / 13 -E	10	2,70 €

TRUBICE KAIFLEX ST SA

Samolepiace trubice Kaiflex ST SA. Dĺžka trubice 2m.



Vonk. Ø potr. (mm)	Kaiflex (SA)			Kaiflex (SA)			Kaiflex (SA)		
	Hr. izolácie 9 mm			Hr. izolácie 13 mm			Hr. izolácie 19 mm		
	Obj. kód	bm/ bal.	EUR/ bm bez DPH	Obj. kód	bm/ bal.	EUR/ bm bez DPH	Obj. kód	bm/ bal.	EUR/ bm bez DPH
15	015 / 9 -SA	240	3,20 €	015 / 13 -SA	154	4,15 €	015 / 19 -SA	86	5,80 €
18	018 / 9 -SA	190	3,40 €	018 / 13 -SA	130	4,50 €	018 / 19 -SA	78	6,20 €
22	022 / 9 -SA	156	3,55 €	022 / 13 -SA	110	4,75 €	022 / 19 -SA	74	6,95 €
28	028 / 9 -SA	124	3,95 €	028 / 13 -SA	86	5,10 €	028 / 19 -SA	58	7,95 €
35	035 / 9 -SA	92	4,30 €	035 / 13 -SA	76	5,30 €	035 / 19 -SA	48	8,95 €
42	042 / 9 -SA	70	4,95 €	042 / 13 -SA	56	6,50 €	042 / 19 -SA	40	10,70 €
48	048 / 9 -SA	60	5,40 €	048 / 13 -SA	48	7,20 €	048 / 19 -SA	30	11,85 €
54	054 / 9 -SA	60	5,90 €	054 / 13 -SA	46	8,65 €	054 / 19 -SA	30	12,75 €
60	060 / 9 -SA	60	7,50 €	060 / 13 -SA	40	9,15 €	060 / 19 -SA	28	14,45 €
76	076 / 9 -SA	54	9,35 €	076 / 13 -SA	34	12,55 €	076 / 19 -SA	28	18,90 €
89	089 / 9 -SA	36	11,10 €	089 / 13 -SA	30	15,15 €	089 / 19 -SA	22	21,40 €

TRUBICE KAIFLEX EF



Vysoko ohybný izolačný materiál so štruktúrou uzavretých buniek (Flexible Elastomeric Foam- FEF).
Izolácia čiernej farby pre teploty od -50°C do +110°C. Dĺžka trubice 2m. Faktor difúzneho odporu $\mu > 8000$.
Súčiniteľ tepelnej vodivosti $\lambda_{0^\circ\text{C}} = 0,036 \text{ W/m.K}$. Trieda reakcie na oheň B-s3,d0.

Vonk. Ø potr. (mm)	Kaiflex EF			Kaiflex EF			Kaiflex EF			Kaiflex EF		
	Hr. izolácie 9 mm			Hr. izolácie 13 mm			Hr. izolácie 19 mm			Hr. izolácie 25 mm		
	Obj. kód	bm/ bal.	EUR/bm bez DPH	Obj. kód	bm/ bal.	EUR/bm bez DPH	Obj. kód	bm/ bal.	EUR/bm bez DPH	Obj. kód	bm/ bal.	EUR/bm bez DPH
6	006 / 9	360	0,95 €	006 / 13	240	1,40 €						
8	008 / 9	340	-	008 / 13	210	-						
10	010 / 9	320	1,15 €	010 / 13	190	1,60 €	010 / 19	108	2,80 €	010 / 25	72	-
12	012 / 9	264	1,20 €	012 / 13	172	1,65 €	012 / 19	100	2,90 €	012 / 25	60	4,10 €
15	015 / 9	224	1,25 €	015 / 13	144	1,85 €	015 / 19	80	3,45 €	015 / 25	56	4,90 €
18	018 / 9	192	1,30 €	018 / 13	128	1,90 €	018 / 19	80	3,85 €	018 / 25	48	5,45 €
22	022 / 9	156	1,45 €	022 / 13	108	2,20 €	022 / 19	72	4,20 €	022 / 25	42	5,55 €
28	028 / 9	124	1,70 €	028 / 13	84	2,40 €	028 / 19	56	4,95 €	028 / 25	40	6,40 €
35	035 / 9	92	1,90 €	035 / 13	76	2,90 €	035 / 19	48	6,00 €	035 / 25	32	7,05 €
42	042 / 9	70	2,20 €	042 / 13	56	3,35 €	042 / 19	40	7,10 €	042 / 25	24	8,80 €
48	048 / 9	60	2,55 €	048 / 13	48	3,90 €	048 / 19	36	8,05 €	048 / 25	24	10,25 €
54	054 / 9	60	3,25 €	054 / 13	46	4,65 €	054 / 19	30	9,10 €	054 / 25	22	11,60 €
60	060 / 9	60	3,80 €	060 / 13	40	5,15 €	060 / 19	28	9,90 €	060 / 25	22	12,55 €
64	064 / 9	54	4,30 €	064 / 13	40	5,65 €	064 / 19	28	10,80 €	064 / 25	18	13,45 €
76	076 / 9	54	5,00 €	076 / 13	34	6,40 €	076 / 19	28	12,90 €	076 / 25	18	15,65 €
89	089 / 9	36	6,00 €	089 / 13	30	7,75 €	089 / 19	22	13,90 €	089 / 25	14	16,95 €

PÁSY KAIFLEX EF



Izolačné pásy zo syntetického kaučuku.

Kaiflex EF			
Hr. izol. (mm)	Rola (šírka 1m) Obj. kód	m ² / bal.	EUR/m ² bez DPH
10	EF 10	10	15,30 €
13	EF 13	8	17,80 €
19	EF 19	6	27,50 €
25	EF 25	4	33,85 €

Samolepiace pásy zo syntetického kaučuku.

Kaiflex EF (SA)			
Hr. izol. (mm)	Rola (šírka 1m) Obj. kód	m ² / bal.	EUR/m ² bez DPH
10	EF 10 -SA	10	23,15 €
13	EF 13 -SA	8	27,80 €
19	EF 19 -SA	6	35,80 €
25	EF 25 -SA	4	42,80 €

ENVIRONMENTAL PRODUCT DECLARATION

as per ISO 14025 and EN 15804+A1

Owner of the Declaration	Kaimann GmbH
Programme holder	Institut Bauen und Umwelt e.V. (IBU)
Publisher	Institut Bauen und Umwelt e.V. (IBU)
Declaration number	EPD-KAI-20210261-IBD1-EN
Issue date	08.10.2021
Valid to	07.10.2026

Kaiflex EF
Kaimann GmbH

www.ibu-epd.com | <https://epd-online.com>



PÁSY KAIFLEX DUCT PLUS

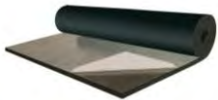

Pásy určené prevažne k izolovaniu potrubí a VZT zariadení.

Faktor difúzneho odporu $\mu > 7000$. Súčiniteľ tepelnej vodivosti $\lambda 0^\circ\text{C} = 0,036 \text{ W/m.K}$. Trieda reakcie na oheň E.

Samolepiace izolačné pásy. Šírka 1m.

Kaiflex DUCT (SA)

Hr. izol. (mm)	Rola (šírka 1m) Obj. kód	m ² / bal.	EUR/m ² bez DPH
6	DC 06 -SA	18	9,60 €
10	DC 10 -SA	10	12,00 €
12	DC 12 -SA	8	14,10 €
15	DC 15 -SA	7	16,90 €
20	DC 20 -SA	6	19,10 €
25	DC 25 -SA	4	24,10 €
30	DC 30 -SA	3	26,10 €

PÁSY KAIFLEX DUCT PLUS

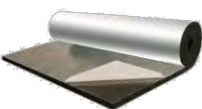

Pásy určené prevažne k izolovaniu potrubí a VZT zariadení.

Faktor difúzneho odporu $\mu > 7000$. Súčiniteľ tepelnej vodivosti $\lambda 0^\circ\text{C} = 0,036 \text{ W/m.K}$. Trieda reakcie na oheň Bs3d0.

Samolepiace izolačné pásy s kovovo lesklým povrchom. Šírka 1m alebo 1,5m.

Kaiflex DUCT ALU plus (SA)

Hr. izol. (mm)	Rola (šírka 1m) Obj. kód	m ² / bal.	EUR/m ² bez DPH	Rola (šírka 1,5m) Obj. kód	m ² / bal.	EUR/m ² bez DPH
6	DC plus ALU 06 -SA	18	12,90 €	DC plus ALU 06 -SA	45	12,90 €
10	DC plus ALU 10 -SA	10	15,30 €	DC plus ALU 10 -SA	30	15,30 €
12	DC plus ALU 12 -SA	8	17,40 €	DC plus ALU 12 -SA	22,5	17,40 €
15	DC plus ALU 15 -SA	7	21,10 €	DC plus ALU 15 -SA	18	21,10 €
20	DC plus ALU 20 -SA	6	22,50 €	DC plus ALU 20 -SA	15	22,50 €
25	DC plus ALU 25 -SA	4	28,60 €	DC plus ALU 25 -SA	12	28,60 €
30	DC plus ALU 30 -SA	3	34,70 €			

TRUBICE KAIFLEX ST PROTECT ALU-TEC



Izolácia s kovovo lesklou vysoko odolnou povrchovou úpravou. Dobrá UV odolnosť a vynikajúca mechanická ochrana. Vhodné ako náhrada oplechovania potrubných rozvodov a zariadení s teplotou od -30°C do +80°C. Dĺžka trubice 1m. Faktor difúzneho odporu $\mu > 10000$. Súčiniteľ tepelnej vodivosti $\lambda 0^\circ\text{C} = 0,034 \text{ W/m.K}$. Trieda reakcie na oheň E.

Vonk. Ø potr. (mm)	Protect ALU-TEC			Protect ALU-TEC			Protect ALU-TEC		
	Hr. izolácie 13 mm			Hr. izolácie 19 mm			Hr. izolácie 25 mm		
	Obj. kód	bm/ bal.	EUR/bm bez DPH	Obj. kód	bm/ bal.	EUR/bm bez DPH	Obj. kód	bm/ bal.	EUR/bm bez DPH
15	015 / 13	72	19,45 €	015 / 19	40	25,05 €			
18	018 / 13	64	19,85 €	018 / 19	40	25,70 €	018 / 25	24	30,80 €
22	022 / 13	54	20,45 €	022 / 19	36	26,45 €	022 / 25	21	33,90 €
28	028 / 13	42	22,05 €	028 / 19	28	28,55 €	028 / 25	20	36,05 €
35	035 / 13	38	23,75 €	035 / 19	24	31,30 €	035 / 25	16	38,30 €
42	042 / 13	28	25,95 €	042 / 19	20	33,40 €	042 / 25	12	41,80 €
48	048 / 13	24	27,55 €	048 / 19	18	36,70 €	048 / 25	12	44,05 €
54	054 / 13	23	30,95 €	054 / 19	15	42,30 €	054 / 25	11	47,80 €
60	060 / 13	20	34,30 €	060 / 19	14	44,65 €	060 / 25	11	54,50 €
64	064 / 13	20	35,55 €	064 / 19	14	46,40 €	064 / 25	9	57,35 €
76	076 / 13	17	39,30 €	076 / 19	14	50,00 €	076 / 25	9	61,95 €
89	089 / 13	15	42,30 €	089 / 19	11	55,50 €	089 / 25	9	-
114	114 / 13		-	114 / 19		-	114 / 25		-
160				160 / 19		-			

Rozmery izolácie od Ø 15 do Ø89 sú s rozrezanou izoláciou v samolepiacom prevedení, rozmery od Ø108 do Ø160 sú len s rozrezanou izoláciou.

PÁSY KAIFLEX PROTECT ALU TEC

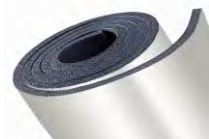

Izolačné pásy s povrchom PROTECT ALU-TEC.

Kaiflex Protect ALU-TEC			
Hr. izol. (mm)	Rola (šírka 1m) Obj. kód	m ² / bal.	EUR/m ² bez DPH
10	ALU-TEC 10	20	41,70 €
13	ALU-TEC 13	14	44,60 €
19	ALU-TEC 19	10	47,65 €
25	ALU-TEC 25	8	60,15 €
32	ALU-TEC 32	6	63,55 €

Samolepiace izolačné pásy s povrchom PROTECT ALU-TEC.

Kaiflex Protect ALU-TEC (SA)			
Hr. izol. (mm)	Rola (šírka 1m) Obj. kód	m ² / bal.	EUR/m ² bez DPH
10	ALU-TEC 10 -SA	20	50,20 €
13	ALU-TEC 13 -SA	14	53,05 €
19	ALU-TEC 19 -SA	10	56,10 €
25	ALU-TEC 25 -SA	8	68,65 €
32	ALU-TEC 32 -SA	6	72,00 €

TRUBICE KAIFLEX EPDM plus



Ohybný izolačný elastomerový materiál na báze EPDM. Izolácia čiernej farby s mimoriadnou odolnosťou proti UV žiareniu a vysokým teplotám. Izolácia sa používa prevažne na izolovanie rozvodov solárnych aplikácií vo vonkajšom prostredí. Rozsah použitia od -50°C do +175°C (stála prevádzková teplota do +150°C). Lepiť len lepidlom Kaiflex EPDM na solar. Dĺžka trubice 2m. Faktor dif. odporu $\mu > 4500$, súčiniteľ tepelnej vodivosti $\lambda 0^\circ\text{C} = 0,038 \text{ W/m.K}$. Trieda reakcie na oheň E.

Vonk. Ø potr. (mm)	Kaiflex EPDM plus			Kaiflex EPDM plus			Kaiflex EPDM plus			Kaiflex EPDM plus			Kaiflex EPDM plus		
	Hr. izolácie 10 mm			Hr. izolácie 13 mm			Hr. izolácie 19 mm			Hr. izolácie 25 mm			Hr. izolácie 32 mm		
	Obj. kód	bm/ bal.	EUR/bm bez DPH	Obj. kód	bm/ bal.	EUR/bm bez DPH	Obj. kód	bm/ bal.	EUR/bm bez DPH	Obj. kód	bm/ bal.	EUR/bm bez DPH	Obj. kód	bm/ bal.	EUR/bm bez DPH
10	010 / 10	220	4,35 €	010 / 13	152	4,70 €									
12	012 / 10	190	4,60 €	012 / 13	136	5,00 €	012 / 19	78	8,65 €	012 / 25	50	14,35 €	012 / 32	32	19,35 €
15	015 / 10	172	4,75 €	015 / 13 E	120	5,65 €	015 / 19 E	72	10,40 €	015 / 25	50	15,90 €	015 / 32	32	21,50 €
18	018 / 10	136	5,10 €	018 / 13 E	106	6,10 €	018 / 19 E	60	10,70 €	018 / 25	40	16,20 €	018 / 32	24	21,85 €
22	022 / 10	112	5,65 €	022 / 13 E	84	6,65 €	022 / 19 E	56	12,60 €	022 / 25	36	17,65 €	022 / 32	24	23,80 €
28	028 / 10	84	6,35 €	028 / 13 E	72	7,20 €	028 / 19 E	40	14,65 €	028 / 25	32	20,15 €	028 / 32	22	27,20 €
35	035 / 10	60	7,15 €	035 / 13 E	50	8,75 €	035 / 19 E	36	16,95 €	035 / 25	24	22,75 €	035 / 32	18	30,65 €
42	042 / 10	50	8,20 €	042 / 13	40	9,75 €	042 / 19	32	19,10 €	042 / 25	22	24,90 €	042 / 32	18	33,60 €
48	048 / 10	40	9,50 €	048 / 13	36	11,75 €	048 / 19	24	23,30 €	048 / 25	18	28,85 €	048 / 32	14	38,95 €
54	054 / 10	36	11,15 €	054 / 13	32	14,10 €	054 / 19	22	26,30 €	054 / 25	18	32,00 €	054 / 32	12	43,15 €
60	060 / 10	32	13,85 €	060 / 13	24	15,45 €	060 / 19	18	29,45 €	060 / 25	16	35,25 €	060 / 32	12	47,60 €
76	076 / 10	20	18,05 €	076 / 13	18	16,55 €	076 / 19	16	36,30 €	076 / 25	12	42,05 €	076 / 32	8	56,70 €
89	089 / 10	18	20,00 €	089 / 13	16	23,10 €	089 / 19	12	40,05 €	089 / 25	12	45,60 €	089 / 32	8	61,60 €

PÁSY KAIFLEX EPDM plus



Pásky zo syntetického kaučuku.

Kaiflex EPDM plus			
Hr. izol. (mm)	Rola (šírka 1m) Obj. kód	m ² /bal.	EUR/m ² bez DPH
6	EPDM plus 06	18	37,50 €
10	EPDM plus 10	10	57,05 €
13	EPDM plus 13	8	68,95 €
19	EPDM plus 19	6	91,80 €
25	EPDM plus 25	4	111,30 €
32	EPDM plus 32	3	133,55 €

TRUBICE TUBOLIT S



izolačné trubice z polyetylénu a s PE fóliou pre zvýšenú ochranu potrubia (modrá alebo červená farba). Dĺžka trubice 2m.

Vonk. Ø potr. (mm)	Tubolit S BLUE				Tubolit S BLUE			Tubolit S BLUE			Tubolit S BLUE		
	Hr. izolácie 9 mm				Hr. izolácie 13 mm			Hr. izolácie 20 mm			Hr. izolácie 25 mm		
	Obj. kód	bm/ bal.	EUR/bm bez DPH		Obj. kód	bm/ bal.	EUR/bm bez DPH	Obj. kód	bm/ bal.	EUR/bm bez DPH	Obj. kód	bm/ bal.	EUR/bm bez DPH
15	015 / 9	234	1,30 €		015 / 13	172	2,56 €				015 / 25	66	5,54 €
18	018 / 9	214	1,36 €		018 / 13	148	2,70 €				018 / 25	56	5,98 €
22	022 / 9	178	1,48 €		022 / 13	128	2,90 €				022 / 25	54	6,62 €
28	028 / 9	130	1,58 €		028 / 13	98	3,20 €	028 / 20	60	4,86 €	028 / 25	46	7,06 €
35	035 / 9	96	2,04 €		035 / 13	72	4,12 €	035 / 20	46	5,28 €			
42	042 / 9	72	2,34 €		042 / 13	56	5,06 €	042 / 20	40	5,92 €			
48	048 / 9	66	2,70 €										

Vonk. Ø potr. (mm)	Tubolit S RED				Tubolit S RED			Tubolit S RED			Tubolit S RED		
	Hr. izolácie 9 mm				Hr. izolácie 13 mm			Hr. izolácie 20 mm			Hr. izolácie 25 mm		
	Obj. kód	bm/ bal.	EUR/bm bez DPH		Obj. kód	bm/ bal.	EUR/bm bez DPH	Obj. kód	bm/ bal.	EUR/bm bez DPH	Obj. kód	bm/ bal.	EUR/bm bez DPH
15	015 / 9	234	1,30 €		015 / 13	172	2,56 €				015 / 25	66	5,54 €
18	018 / 9	214	1,36 €		018 / 13	148	2,70 €				018 / 25	56	5,98 €
22	022 / 9	178	1,48 €		022 / 13	128	2,90 €				022 / 25	54	6,62 €
28	028 / 9	130	1,58 €		028 / 13	98	3,20 €	028 / 20	60	4,86 €	028 / 25	46	7,06 €
35	035 / 9	96	2,04 €		035 / 13	72	4,12 €	035 / 20	46	5,28 €			
42	042 / 9	72	2,34 €		042 / 13	56	5,06 €	042 / 20	40	5,92 €			
48	048 / 9	66	2,70 €										

HADICE TUBOLIT S PLUS



Návleková izolácia z polyetylénu a s PE fóliou na ochranu potrubia v stene alebo podlahe (modrá alebo červená farba). Dĺžka hadice 20m.

Vonk. Ø (mm)	Tubolit S+ BLUE			
	Hr. izolácie 4 mm			
	Obj. kód	bm/ bal.	EUR/bm bez DPH	EUR/ks bez DPH
15	015 / 4	520	0,78 €	15,60 €
18	018 / 4	440	0,84 €	16,80 €
22	022 / 4	400	0,88 €	17,60 €
28	028 / 4	320	0,98 €	19,60 €
35	035 / 4	280	1,04 €	20,80 €
42	042 / 4	240	1,14 €	22,80 €

Vonk. Ø (mm)	Tubolit S+ RED			
	Hr. izolácie 4 mm			
	Obj. kód	bm/ bal.	EUR/bm bez DPH	EUR/ks bez DPH
15	015 / 4	520	0,78 €	15,60 €
18	018 / 4	440	0,84 €	16,80 €
22	022 / 4	400	0,88 €	17,60 €
28	028 / 4	320	0,98 €	19,60 €
35	035 / 4	280	1,04 €	20,80 €
42	042 / 4	240	1,14 €	22,80 €

TRUBICE TUBOLIT DG



Izolačný materiál na báze polyetylénu šedej farby určený k izolovaniu potrubia kúrenia a sanity.

Izolácia výrazne znižuje energetické straty až o 80%. Dĺžka trubice 2m.

Rozsah použitia do +100°C. Súčiniteľ tepelnej vodivosti $\lambda_{0^\circ\text{C}} = 0,040 \text{ W/m.K}$. Trieda reakcie na oheň E.

Vonk. Ø potr. (mm)	Tubolit DG			Tubolit DG			Tubolit DG			Tubolit DG		
	Hr. izolácie 5 mm			Hr. izolácie 9 mm			Hr. izolácie 13 mm			Hr. izolácie 20 mm		
	Obj. kód	bm/ bal.	EUR/bm bez DPH	Obj. kód	bm/ bal.	EUR/bm bez DPH	Obj. kód	bm/ bal.	EUR/bm bez DPH	Obj. kód	bm/ bal.	EUR/bm bez DPH
12	012 / 5	520	0,40 €									
15	015 / 5	390	0,42 €	015 / 9	262	0,74 €	015 / 13	192	1,14 €	015 / 20	100	2,00 €
18	018 / 5	280	0,48 €	018 / 9	230	0,78 €	018 / 13	156	1,22 €	018 / 20	88	2,10 €
20	020 / 5	280	0,52 €	020 / 9	212	0,80 €	020 / 13	140	1,26 €			
22	022 / 5	240	0,54 €	022 / 9	182	0,86 €	022 / 13	140	1,30 €	022 / 20	80	2,42 €
25	025 / 5	230	0,58 €	025 / 9	138	0,88 €	025 / 13	124	1,40 €			
28	028 / 5	180	0,62 €	028 / 9	136	0,94 €	028 / 13	108	1,48 €	028 / 20	68	2,84 €
32	032 / 5	170	0,82 €	032 / 9	122	1,12 €	032 / 13	90	1,78 €			
35	035 / 5	140	0,94 €	035 / 9	102	1,24 €	035 / 13	88	2,06 €	035 / 20	50	3,14 €
40				040 / 9	82	1,34 €	040 / 13	70	2,28 €			
42				042 / 9	72	1,38 €	042 / 13	60	2,42 €	042 / 20	44	3,60 €
48				048 / 9	70	1,64 €	048 / 13	60	2,68 €	048 / 20	40	5,32 €
50				050 / 9	66	1,78 €	050 / 13	56	2,80 €			
54				054 / 9	60	2,08 €	054 / 13	50	3,08 €	054 / 20	32	5,32 €
60				060 / 9	52	2,30 €	060 / 13	38	3,20 €	060 / 20	28	5,56 €
64				064 / 9	50	2,66 €	064 / 13	32	3,44 €	064 / 20	26	6,22 €
76				076 / 9	32	3,22 €	076 / 13	26	4,12 €	076 / 20	20	6,54 €
89				089 / 9	22	3,72 €	089 / 13	22	5,10 €	089 / 20	18	10,82 €
110							110 / 13	16	6,80 €	110 / 20	12	14,04 €
114							114 / 13	12	7,20 €	114 / 20	12	14,46 €
125							125 / 13		8,12 €			

Vonk. Ø potr. (mm)	Tubolit DG			Tubolit DG		
	Hr. izolácie 25 mm			Hr. izolácie 30 mm		
	Obj. kód	bm/ bal.	EUR/bm bez DPH	Obj. kód	bm/ bal.	EUR/bm bez DPH
15	015 / 25	66	3,54 €			
18	018 / 25	56	3,74 €	018 / 30	56	4,40 €
22	022 / 25	54	4,30 €	022 / 30	46	4,68 €
28	028 / 25	56	4,74 €	028 / 30	40	4,86 €
35	035 / 25	32	5,22 €	035 / 30	34	5,48 €
42	042 / 25	28	5,96 €	042 / 30	26	6,26 €
48	048 / 25	24	6,50 €	048 / 30	22	6,88 €
54	054 / 25	24	7,10 €	054 / 30	22	7,50 €
60	060 / 25	24	8,02 €	060 / 30	18	8,70 €
76	076 / 25	16	9,42 €	076 / 30	16	12,26 €
89	089 / 25	14	14,42 €	089 / 30	10	15,86 €
114				114 / 30	8	19,16 €

HADICE TUBOLIT AR Fonoblok

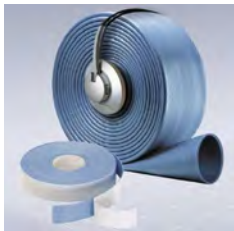

Návleková izolácia pre oceľové potrubia odpadovej vody a dažďových zvodov (útlm hluku, ochrana proti kondenzácii). Dĺžka hadice 15m.

Vonk. Ø potr. (mm)	Tubolit AR			
	Hr. izolácie 5 mm			
	Obj. kód	bm/ bal.	EUR/bm bez DPH	EUR/ks bez DPH
57	AR 050/5	135	1,42 €	21,30 €
64	AR 060/5	120	1,68 €	25,20 €
76	AR 070/5	105	1,90 €	28,50 €
89	AR 090/5	75	2,10 €	31,50 €
108	AR 100/5	75	2,44 €	36,60 €
133	AR 125/5	60	2,86 €	42,90 €
160	AR 150/5	45	3,46 €	51,90 €

HADICE TUBOLIT ARW Fonowave



Návleková izolácia PVC potrubia odpadovej vody a dažďových zvodov (útlm hluku, ochrana proti kondenzácii). Dĺžka hadice 10m.

Vonk. Ø potr. (mm)	Tubolit ARW			
	Hr. izolácie 9 mm			
	Obj. kód	bm/ bal.	EUR/bm bez DPH	EUR/ks bez DPH
57	ARW 050/9	80	3,06 €	30,60 €
76	ARW 070/9	60	4,06 €	40,60 €
89	ARW 090/9	50	4,72 €	47,20 €
110	ARW 100/9	50	5,04 €	50,40 €
133	ARW 125/9	40	6,18 €	61,80 €



Mirelon POLAR - izolácia z penového polyetylénu laminovaná zosílenou hliníkovou fóliou. Vhodný pre použitie v priestoroch, ktoré je nutné z hygienických dôvodov umývať.
 Dĺžka trubice 2m. Rozsah použitia do +90°C. Súčiniteľ tepelnej vodivosti $\lambda_{10^\circ\text{C}} = 0,046 \text{ W/m.K}$. Trieda reakcie na oheň E.

Vonk. Ø potr. (mm)	Mirelon POLAR			Mirelon POLAR			Mirelon POLAR			Mirelon POLAR		
	Hr. izolácie 9 mm			Hr. izolácie 13 mm			Hr. izolácie 20 mm			Hr. izolácie 25 mm		
	Obj. kód	bm/ bal.	EUR/bm bez DPH	Obj. kód	bm/ bal.	EUR/bm bez DPH	Obj. kód	bm/ bal.	EUR/bm bez DPH	Obj. kód	bm/ bal.	EUR/bm bez DPH
12	012 / 9	520	1,60 €	012 / 13	260	2,00 €						
15	015 / 9	400	1,70 €	015 / 13	250	2,20 €	015 / 20	160	4,10 €			
18	018 / 9	370	1,80 €	018 / 13	240	2,40 €	018 / 20	140	4,40 €			
20	020 / 9	320	2,00 €	020 / 13	204	3,10 €	020 / 20	126	5,50 €			
22	022 / 9	280	2,00 €	022 / 13	204	3,10 €	022 / 20	120	5,50 €	022 / 25	80	7,50 €
25	025 / 9	216	2,50 €	025 / 13	160	3,40 €	025 / 20	90	6,40 €	025 / 25	68	9,10 €
28	028 / 9	216	2,50 €	028 / 13	160	3,40 €	028 / 20	90	6,40 €	028 / 25	68	9,10 €
32	032 / 9	198	3,00 €	032 / 13	120	4,20 €	032 / 20	80	7,30 €	032 / 25	66	11,10 €
35	035 / 9	168	3,20 €	035 / 13	108	4,50 €	035 / 20	80	8,00 €	035 / 25	60	12,20 €
40	040 / 9	130	3,60 €	040 / 13	94	5,10 €	040 / 20	66	8,50 €	040 / 25	54	13,50 €
45	045 / 9	120	3,70 €	045 / 13	90	5,50 €	045 / 20	66	9,00 €	045 / 25	46	14,90 €
48	048 / 9	90	4,00 €	048 / 13	84	5,70 €	048 / 20	60	9,40 €	048 / 25	42	17,00 €
50	050 / 9	90	4,20 €	050 / 13	80	6,10 €	050 / 20	60	10,10 €	050 / 25	42	19,00 €
54	054 / 9	90	4,40 €	054 / 13	70	6,40 €	054 / 20	48	10,50 €	054 / 25	40	20,50 €
60	060 / 9	70	4,60 €	060 / 13	60	6,50 €	060 / 20	40	10,70 €	060 / 25	32	21,70 €
64	064 / 9	70	5,10 €	064 / 13	60	6,80 €	064 / 20	40	11,20 €	064 / 25	32	24,50 €
76	076 / 9	48	6,00 €	076 / 13	40	8,70 €	076 / 20	30	13,40 €	076 / 25	26	34,80 €
89				089 / 13	30	9,90 €	089 / 20	24	14,50 €	089 / 25	20	42,00 €
108				108 / 13	24	13,00 €	108 / 20	20	20,00 €	108 / 25	16	51,00 €
110				110 / 13	24	14,40 €	110 / 20	18	23,40 €	110 / 25	14	55,10 €
134				134 / 13			134 / 20	12	29,00 €	134 / 25	12	62,90 €

TRUBICE Mirelon STABIL



Mirelon STABIL- izolácia z penového polyetylénu laminované polyetylénovou tkaninou (modrá, červená a biela farba).

Dĺžka trubice 2m. Rozsah použitia do +90°C. Súčiniteľ tepelnej vodivosti $\lambda_{10^\circ\text{C}} = 0,046 \text{ W/m.K}$. Trieda reakcie na oheň E.

Vonk. Ø potr. (mm)	Mirelon STABIL			Mirelon STABIL			Mirelon STABIL			Mirelon STABIL		
	Hr. izolácie 9 mm			Hr. izolácie 13 mm			Hr. izolácie 20 mm			Hr. izolácie 25 mm		
	Obj. kód	bm/ bal.	EUR/bm bez DPH	Obj. kód	bm/ bal.	EUR/bm bez DPH	Obj. kód	bm/ bal.	EUR/bm bez DPH	Obj. kód	bm/ bal.	EUR/bm bez DPH
12				012 / 13	260	1,90 €						
15				015 / 13	250	2,10 €	015 / 20	160	4,10 €			
18				018 / 13	240	2,40 €	018 / 20	140	4,30 €			
20				020 / 13	204	3,00 €	020 / 20	126	5,50 €			
22	022 / 9	280	2,00 €	022 / 13	204	3,00 €	022 / 20	120	5,50 €	022 / 25	80	6,40 €
25	025 / 9	216	2,50 €	025 / 13	160	3,40 €	025 / 20	90	6,30 €	025 / 25	68	7,70 €
28	028 / 9	216	2,50 €	028 / 13	160	3,40 €	028 / 20	90	6,30 €	028 / 25	68	7,70 €
32	032 / 9	198	2,90 €	032 / 13	120	4,10 €	032 / 20	80	7,20 €	032 / 25	66	9,20 €
35	035 / 9	168	3,20 €	035 / 13	108	4,50 €	035 / 20	80	7,90 €	035 / 25	60	10,00 €
40	040 / 9	130	3,60 €	040 / 13	94	5,10 €	040 / 20	66	8,40 €	040 / 25	54	10,90 €
45	045 / 9	120	3,70 €	045 / 13	90	5,50 €	045 / 20	66	8,90 €	045 / 25	46	11,90 €
48	048 / 9	90	4,00 €	048 / 13	84	5,70 €	048 / 20	60	9,30 €	048 / 25	42	13,60 €
50	050 / 9	90	4,10 €	050 / 13	80	6,00 €	050 / 20	60	10,00 €	050 / 25	42	15,00 €
54	054 / 9	90	4,30 €	054 / 13	70	6,40 €	054 / 20	48	10,40 €	054 / 25	40	16,10 €
60	060 / 9	70	4,60 €	060 / 13	60	6,40 €	060 / 20	40	10,60 €	060 / 25	32	17,20 €
64	064 / 9	70	5,00 €	064 / 13	60	6,70 €	064 / 20	40	11,10 €	064 / 25	32	19,30 €
76	076 / 9	48	5,90 €	076 / 13	40	8,60 €	076 / 20	30	13,30 €	076 / 25	26	28,40 €
89				089 / 13	30	9,80 €	089 / 20	24	14,40 €	089 / 25	20	35,10 €
108				108 / 13	24	12,90 €	108 / 20	20	19,20 €	108 / 25	16	42,60 €
110				110 / 13	24	14,20 €	110 / 20	18	22,50 €	110 / 25	14	45,80 €
134							134 / 20	12	27,90 €	134 / 25	12	52,70 €

PÁSY PE



Izolačné pásy z polyetylénu určené na izolovanie kúrenia, sanity, nádrží, vzduchotechniky a pod.

Pásy - v šedej farbe.

PE pás (bez povrchovej úpravy)				PE pás (bez povrchovej úpravy, samolep)			
Hr. izol. (mm)	Rola (šírka 1m) Obj. kód	m ² / bal.	EUR/m ² bez DPH	Hr. izol. (mm)	Rola (šírka 1m) Obj. kód	m ² / bal.	EUR/m ² bez DPH
5*	PE 5 *	-	2,90 €	5*	PE 5 -SA	-	11,80 €
10	PE 10	20	5,80 €	10	PE 10 -SA	20	15,15 €
15	PE 15	20	8,70 €	15	PE 15 -SA	20	18,45 €
20	PE 20	20	11,55 €	20	PE 20 -SA	20	21,80 €
25	PE 25	-	14,45 €	25	PE 25 -SA	-	25,15 €
30	PE 30	-	17,35 €	30	PE 30 -SA	-	28,50 €

* šírka pásov 1 alebo 1,1m

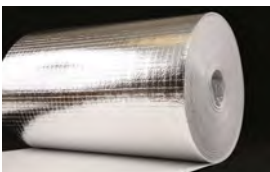

Pásy - v bielej alebo šedej farbe.

PE pás (AL - hliníková fólia)				PE pás (AL - hliníková fólia, samolep)			
Hr. izol. (mm)	Rola (šírka 1m) Obj. kód	m ² / bal.	EUR/m ² bez DPH	Hr. izol. (mm)	Rola (šírka 1m) Obj. kód	m ² / bal.	EUR/m ² bez DPH
5	PE AL 5	50	4,65 €	5	PE AL 5 -SA	50	13,10 €
10	PE AL 10	20	7,55 €	10	PE AL 10 -SA	20	16,00 €
15	PE AL 15	20	10,40 €	15	PE AL 15 -SA	20	18,90 €
20	PE AL 20	20	13,30 €	20	PE AL 20 -SA	20	21,70 €
25	PE AL 25	-	16,15 €	25	PE AL 25 -SA	-	24,60 €
30	PE AL 30	-	19,00 €	30	PE AL 30 -SA	-	27,45 €

PE pás (PET - polyetylenetereftalátová reflexná fólia)			
Hr. izol. (mm)	Rola (šírka 0,7m) Obj. kód	m / bal.	EUR/m ² bez DPH
2	PE PET 2	25	2,50 €
3	PE PET 3	25	2,90 €

PÁSY TROCELLEN APLOMB



Hlukoizolácia potrubia odpadovej vody.

APLOMB 11

Hr. izol. (mm)	Rola (šírka 1m) Obj. kód	m ² /bal.	EUR/m ² bez DPH
15	APLOMB 11	3	78 €

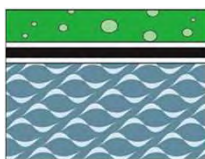

- Vrstva chemicky zosietenej PE peny hr. 3mm, kaširovaná kovovo naparenou čiernou fóliou.
- Olovená platňa hrúbky 0,35 mm (4 kg/m²).
- Chemicky zosietená polyetylénová vrstva peny hrúbky 12 mm.

Hlukoizolácia stien a pod.

APLOMB 22

Hr. izol. (mm)	Rola (šírka 1m) Obj. kód	m ² /bal.	EUR/m ² bez DPH
6	APLOMB 22	3	81 €



- Vrstva chemicky zosietenej PE peny, kaširovaná kovovo naparenou čiernou fóliou hrúbky 3mm.
- Olovená platňa hrúbky 0,35 mm (4 kg/m²).
- Vrstva chemicky zosietenej PE peny, kaširovaná kovovo naparenou čiernou fóliou hrúbky 3mm.
- CL1 - povrchová úprava s čiernou tkaninou

NOVINKA! Testovaný útlm
hľuku pre všestranné využitie

Kaiflex® SL

Útlm hľuku. Prispieva k pocitu kludu, ticha a pohodlia.

- Efektívna ochrana hľuku v budovách, zvyšuje produktivitu a zdravotný komfort užívateľov
- Spoľahlivo zabraňuje kondenzácií a znižuje riziko korózie pod izoláciou
- Zvyšuje ochranu stavebných materiálov a vybavenia budov pred poškodením spôsobenou vlhkosťou
- Vaša ideálna voľba pre stavebné projekty s vysokými ekonomickými požiadavkami
- Obzvlášť vysoká ochrana povrchových plôch

PÁSY ArmaComfort



Špeciálny typ izolácie pre znižovanie hluku rozvodov dažďovej vody a odpadového potrubia. Súčiniteľ tepelnej vodivosti $\lambda_{10^{\circ}\text{C}} = 0,040\text{W/m.K}$. $R_w=26\text{dB}$. Redukcia hluku prenášaného konštrukciou:
na plastových potrubiach $\leq 14\text{ dB (A)}$
na systéme Geberit PE HD $\leq 16\text{ dB (A)}$
na systéme Geberit Silent db20 $\leq 18\text{ dB (A)}$.

ArmaComfort AB

Hr. izol. (mm)	Rola (šírka 1m) Obj. kód	$m^2/\text{bal.}$	EUR/m ² bez DPH
11	AO-11-99/E-AB	2	68 €



Špeciálny typ izolácie pre znižovanie hluku rozvodov dažďovej vody, kanalizácie a odpadového potrubia. Je špeciálne určený pre neobytné budovy ako sú napr. kancelárie, hotely, nemocnice, školy, nákupné a kongresové centrá. Izolácia sa skladá z akustickej bariéry (EPDMA-eva peny) v hr. 2mm, ktorá ma na povrchu AL fóliou a z polyuretánovej peny hr. 10mm. Trieda reakcie na oheň B s1,d0. Súčiniteľ tepelnej vodivosti $\lambda_{10^{\circ}\text{C}} = 0,040\text{ W/m.K}$. $R_w=28\text{dB}$.

ArmaComfort AB ALU

Hr. izol. (mm)	Rola (šírka 1m) Obj. kód	$m^2/\text{bal.}$	EUR/m ² bez DPH
12	AO-12-99/E-AB-AL	2	



Špeciálny typ izolácie pre znižovanie hluku rozvodov dažďovej vody, kanalizácie a odpadového potrubia. Je vhodný na použitie v obytných a neobytných budovách pre zvýšenie bezpečnosti a zabránenie vzniku korózie. Izolácia sa skladá z akustickej bariéry (EPDMA-eva peny) v hr. 2mm, ktorá ma na povrchu AL fóliou a z elastomerickéj peny Armaflex hr. 9mm. Trieda reakcie na oheň B s1,d0. Súčiniteľ tepelnej vodivosti $\lambda_{10^{\circ}\text{C}} = 0,042\text{ W/m.K}$.

Redukcia hluku prenášaného konštrukciou: na systéme Geberit Silent db20 $\leq 18\text{ dB (A)}$.

ArmaComfort AB ALU PLUS

Hr. izol. (mm)	Rola (šírka 1m) Obj. kód	$m^2/\text{bal.}$	EUR/m ² bez DPH
11	AO-11-99/E-AB-AL+	2	81 €
11	AO-11-99/E25-AB-AL+	25	

PÁSY Kaisound

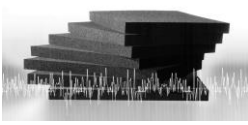

Izolácia KAISOUND sa používa v priemyselných komplexoch a obytných budovách na účinné tlmenie hluku. Používa sa aj k odstráneniu tzv. štruktúrného hluku, ktorý sa šíri stenami, podlahami alebo konštrukciami v budovách. Správnym výberom typu izolácie (obj.hmotnosti 120 alebo 240kg/m³) je možné systém izolácie presne prispôbiť konkrétnemu prostrediu, intenzite a frekvencii hluku.



Kaisound 140 SA (samolep)			
Hr. izol. (mm)	(1,2x0,84m) Obj.kód	m ² /bal.	EUR/m ² bez DPH
6	KS140-06 SA M	16	- €
10	KS140-10 SA M	10	49,00 €
15	KS140-15 SA M	6	- €
20	KS140-20 SA M	5	86,00 €
25	KS140-25 SA M	4	- €
50	KS140-50 SA M	2	- €

Kaisound 240 SA (samolep)			
Hr. izol. (mm)	(1,2x0,84m) Obj.kód	m ² /bal.	EUR/m ² bez DPH
6	KS240-06 SA M	16	- €
10	KS240-10 SA M	10	- €
15	KS240-15 SA M	6	- €
20	KS240-20 SA M	5	- €
25	KS240-25 SA M	4	- €
50	KS240-50 SA M	2	- €

PÁSY Kaivenience



Hydrofóbný a flexibilný izolačný materiál s otvorenými bunkami na báze syntetického kaučuku s ťažkou bezolovnatou fóliou na báze polyméru (vyplnená anorganickými materiálmi).

Súčiniteľ redukcie hluku prenášaného konštrukciou: na plastových potrubiach ≤ 15 dB (A).

Trieda reakcie na oheň E.



Kaivenience AB

Hr. izol. (mm)	Rola (1,18 x 0,83 m) Obj. kód	m ² /bal.	EUR/m ² bez DPH
5	AB-05	2,94	37,00 €
10	AB-10	1,96	39,00 €

Kaivenience AB SA (samolep)

Hr. izol. (mm)	Rola (1,18 x 0,83 m) Obj. kód	m ² /bal.	EUR/m ² bez DPH
5	AB-05-SA	19,6	0,00 €
10	AB-10-SA	9,8	0,00 €



Špeciálny typ izolácie pre znižovanie hluku rozvodov dažďovej vody, kanalizácie a odpadového potrubia. Je vhodný na použitie v obytných a neobytných budovách pre zvýšenie bezpečnosti a zabránenie vzniku korózie.

Hydrofóbný a flexibilný izolačný materiál s otvorenými bunkami na báze syntetického kaučuku s ťažkou bezolovnatou fóliou na báze polyméru (vyplnená anorganickými materiálmi) a ALU fóliou zosilnenou sklotextilnou mriežkou.

Redukcia hluku prenášaného konštrukciou: na plastových potrubiach ≤ 15 dB (A).

Trieda reakcie na oheň D s2,d0.

Kaivenience AB ALU

Hr. izol. (mm)	Rola (1,18 x 0,83 m) Obj. kód	m ² /bal.	EUR/m ² bez DPH
5	AB-05-ALU	2,94	41,00 €
10	AB-10-ALU	1,96	43,00 €

Kaivenience AB ALU SA (samolep)

Hr. izol. (mm)	Rola (1,18 x 0,83 m) Obj. kód	m ² /bal.	EUR/m ² bez DPH
5	AB-05-ALU SA	19,6	0,00 €
10	AB-10-ALU SA	9,8	0,00 €

PÁSY Kaiflex SL



Špeciálny typ izolácie pre znižovanie hluku rozvodov a zariadení v budovách. Spoľahlivo zabraňuje vzniku kondenzácie a znižuje riziko vzniku korózie pod izoláciou.

Hydrofóbný a flexibilný izolačný materiál zložený z izolácie Kaiflex ST hr.10mm s uzatvorenými bunkami na báze syntetického kaučuku s ťažkou bezolovnatou fóliou na báze polyméru hr. 2mm.

Vážený index zníženia hluku R_w (C; Ctr) = 25 (-1;-4) dB. Faktor difúzneho odporu $\mu > 7 000$.

Trieda reakcie na oheň E.

Kaiflex SL

Hr. izol. (mm)	Rola (2 x 1 m) Obj. kód	m ² /bal.	EUR/m ² bez DPH
10+2	SL-Sh BXS-10	2	40,00 €

Kaiflex SL SA (samolep)

Hr. izol. (mm)	Rola (2 x 1 m) Obj. kód	m ² /bal.	EUR/m ² bez DPH
10+2	SL-Sh BXS-10 SA	2	45,00 €

TECHNICKÉ IZOLÁCIE A PRÍSLUŠENSTVO



LAMELOVÉ PÁSY s ALS fóliou "ML3"

Lamelový izolačný pás zo skleneného vlákna nalepený na hliníkovú fóliu vystuženú sklotextilnou mriežkou.

CLIMCOVER				Ventilam ALU/ML-3			
hr. (mm)	EUR/m2 bez DPH	m ² / bal.	m ² / pal.	hr. (mm)	EUR/m2 bez DPH	m ² / bal.	m ² / pal.
20	8,90 €	12	144	20	8,60 €	14,4	172,8
30	11,65 €	9,6	115,2	30	10,95 €	9,6	115,2
40	13,55 €	7,2	86,4	40	12,95 €	7,2	86,4
50	15,70 €	6	72	50	15,00 €	6	72
60	18,65 €	4,8	57,6	60	17,75 €	4,8	57,6
80	23,45 €	3,6	43,2	80	22,40 €	3,6	43,2
100	28,20 €	3	36	100	27,35 €	3	36

Max. 250/100°C. Šírka 2x0,6m.

Max. 250/100°C. Šírka 1,2m.



Ventilam ALU/ML-3 PLUS			
hr. (mm)	EUR/m2 bez DPH	m ² / bal.	m ² / pal.
20	10,35 €	12	144
30	13,10 €	8	96
40	16,00 €	6	72
50	17,75 €	5	60

Pás so samolepiacou vrstvou.
Max.50 °C. Šírka 1m.

LAMELOVÉ PÁSY s ALS fóliou "LSP"

Lamelový izolačný pás z čadičovej vlny nalepený na hliníkovú fóliu vystuženú sklotextilnou mriežkou.

Orstech LSP 40 (40kg/m3)				Orstech LSP H (55kg/m3)				Orstech LSP PYRO (65kg/m3)			
hr. (mm)	EUR/m2 bez DPH	m ² / bal.	m ² / pal.	hr. (mm)	EUR/m2 bez DPH	m ² / bal.	m ² / pal.	hr. (mm)	EUR/m2 bez DPH	m ² / bal.	m ² / pal.
20	9,45 €	8	160	20	10,35 €	8	160	20	12,80 €	5	105
30	11,35 €	5	100	30	12,55 €	5	100	30	15,70 €	5	84
40	13,55 €	4	80	40	15,30 €	4	80	40	18,65 €	4 (3)	63
50	15,85 €	3	60	50	18,05 €	3	60	50	20,10 €	4	63
60	17,60 €	3	60	60	19,20 €	3	63	60	26,05 €	3	42
80	21,95 €	2	40	80	24,45 €	2	40	80	31,15 €	2,8	36
100	26,75 €	2,3	41,4	100	28,80 €	2,3	41,4	100			

Max.250/100°C. Šírka 1m.

Max.600/100°C. Šírka 1m.

Max.600/100°C. Šírka 1m.



ROHOŽE s drôteným pletivom



TECH Wired Mat MT 4.0 (DE)				TECH Wired Mat MT 5.0 (DE)			
hr. (mm)	EUR/m2 bez DPH	m ² / bal.	m ² / pal.	hr. (mm)	EUR/m2 bez DPH	m ² / bal.	m ² / pal.
30	16,30 €	4	180	30	19,65 €	4	160
40	20,10 €	4	160	40	23,30 €	4	120
50	24,15 €	2,5	112,5	50	25,75 €	2,5	100
60	28,35 €	2,5	100	60	30,55 €	2,5	75
70	31,85 €	2	100	70	35,20 €	2,5	75
80	35,65 €	2	80	80	38,25 €	2	60
90	39,10 €	2	60	90	44,05 €	2	60
100	40,70 €	2	60	100	52,80 €	1,5	45
120	50,05 €	2	40	120	60,95 €	1,5	45

Max 600°C. Šírka 0,5m (80kg/m³) Max 620°C. Šírka 0,5m (100kg/m³)



TECH Wired Mat MT 3.1 (PL)				TECH Wired Mat MT 4.1 (PL)				TECH Wired Mat MT 5.1 (PL)				TECH Wired Mat MT 6.1 (PL)			
hr. (mm)	EUR/m2 bez DPH	m ² / bal.	m ² / pal.	hr. (mm)	EUR/m2 bez DPH	m ² / bal.	m ² / pal.	hr. (mm)	EUR/m2 bez DPH	m ² / bal.	m ² / pal.	hr. (mm)	EUR/m2 bez DPH	m ² / bal.	m ² / pal.
50	18,90 €	5	105	30	16,30 €	6	126	30	19,65 €	6	126	50	29,80 €	4	84
60	22,40 €	5	105	40	20,10 €	5,5	115,5	40	23,30 €	5	105	80	44,05 €	2,5	52,5
80	27,50 €	4	84	50	24,15 €	4	84	50	25,75 €	4	84	100	53,80 €	2	42
100	33,60 €	2,5	52,5	60	28,35 €	3,5	73,5	60	30,55 €	3	63	120	62,80 €	2	42
120	40,30 €	2,5	52,5	70	31,85 €	3,5	73,5	70	35,20 €	2,5	52,5	Max 700°C. Šírka 1m			
Max 560°C. Šírka 1m				80	35,65 €	3	63	80	38,25 €	2,5	52,5	Max 660°C. Šírka 1m (100kg/m ³)			
				90	39,10 €	2,5	52,5	90	44,05 €	2	42				
				100	40,70 €	2,5	52,5	100	52,80 €	2	42				
				120	50,05 €	2	42	120	60,95 €	2	42				

DOSKY



Orstech 45				Orstech 45 H				Orstech 65				Orstech 100			
hr. (mm)	EUR/m2 bez DPH	m ² / bal.	m ² / pal.	hr. (mm)	EUR/m2 bez DPH	m ² / bal.	m ² / pal.	hr. (mm)	EUR/m2 bez DPH	m ² / bal.	m ² / pal.	hr. (mm)	EUR/m2 bez DPH	m ² / bal.	m ² / pal.
40	8,30 €	6	60	40	12,55 €	6	60	40	11,65 €	6	60	40	16,60 €	6	60
50	10,35 €	5	50	50	14,55 €	5	50	50	14,00 €	5	50	50	20,80 €	4	50
60	12,40 €	4	40	60	16,60 €	4	40	60	16,90 €	4	40	60	24,75 €	4	40
80	16,75 €	3	30	80	20,95 €	3	30	80	22,25 €	3	30	80	33,00 €	3	30
100	20,25 €	2,5	25	100	24,45 €	2,5	25	100	27,50 €	2,5	25	100	41,45 €	2	25
120	24,75 €	2	20	120	28,95 €	2	20	120	33,00 €	2	20	Max.660°C. Rozmery:0,5 x 1m.			
Max.400°C. Rozmery:0,5 x 1m.				Max.400/100°C. Rozmery:0,5 x 1m.				Max.600°C. Rozmery:0,5 x 1m.							

PROTIPOŽIARNE SYSTÉMY

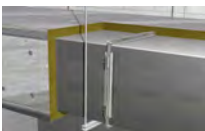

Orstech 65 H			
hr. (mm)	EUR/m ² bez DPH	m ² / bal.	m ² / pal.
40	16,60 €	6	60
60	21,95 €	4	40

Rozmery: 0,5 x 1m.

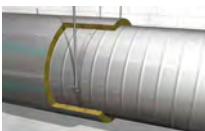

Orstech LSP PYRO			
hr. (mm)	EUR/m ² bez DPH	m ² / bal.	m ² / pal.
40	15,70 €	4	84,0
50	18,65 €	3	63,0

Šírka 1m

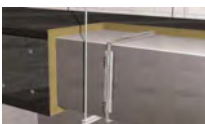

U PROTECT SLAB 4.0 Alu1 BLACK			
hr. (mm)	EUR/m ² bez DPH	m ² / bal.	m ² / pal.
50	57,75 €	5,76	69,12
70	65,30 €	3,6	43,2
80	71,25 €	3,6	43,2
100	88,25 €	2,88	34,56

Rozmery: 0,6 x 1,2m.



U PROTECT WIRED MAT 4.0 Alu1 BLACK			
hr. (mm)	EUR/m ² bez DPH	m ² / bal.	m ² / pal.
50	67,45 €	7,2	129,6
70	80,70 €	5,16	92,88
80	87,25 €	4,44	79,92
120	121,70 €	3	54,0

Šírka: 2 x 0,6m

Príslušenstvo (U PROTECT):

ISOVER PROTECT BSK (lepídlo) na riešenie upchávky v mieste prechodu VZT potrubia. Spotreba 0,3-1,5kg/m ² .	kg / bal.	EUR/kg bez DPH	EUR/bal. bez DPH
	8	20,79 €	166,30 €
ISOVER PROTECT BSF (tmel) Tmel určený na riešenie upchávky v mieste prechodu VZT potrubia.	kg / bal.	EUR/kg bez DPH	EUR/bal. bez DPH
	15	69,50 €	1 042,45 €
PROTECT BLACK TAPE Páska šírka 90 mm x 100m	ks / bal.	EUR/m bez DPH	EUR/ks bez DPH
	24	2,98 €	298,35 €

ORSTECH PROTECT - systém protipožiarnej ochrany VZT EI 30, 45, 60 min.

Protipožiarne pasívne ochrany vzduchotechnického potrubia určený na dosiahnutie požiarnej odolnosti 30 až 60 min. (EI 30 S, 45 S, 60 S) pre zvislú a vodorovnú orientáciu potrubia pri pôsobení ohňa z vonka potrubia. Izolácia sa k potrubiu prichytáva prostredníctvom navarovacích trňov (spotreba cca 16ks/m²).

Hranaté potrubie (ORSTECH 65H):	Potrubie	EI 45 S	EI 60 S	EI 60 S
Požiar z vonka	↔	40 mm		
Požiar z vonka	↕		40 mm	60 mm
Požiar z vonka	↔↕			60 mm

Kruhové potrubie (ORSTECH LSP PYRO):	Potrubie	EI 30 S	EI 60 S	EI 60 S	
Požiar z vonka	↔	40 mm			vsuvky + tmel
Požiar z vonka	↕		40 mm	40 mm	vsuvky + tmel
Požiar z vonka	↔↕			50 mm	prírubby + keramická páska

ULTIMATE PROTECT - systém protipožiarnej ochrany VZT EI 15, 30, 45, 60, 90, 120 min.

Protipožiarne pasívne ochrany vzduchotechnického potrubia určený na dosiahnutie požiarnej odolnosti 15, 30, 60, 90 a 120 min. (EI 15S, 30S, 45S, 60S, 90S, 120S) pre zvislú aj vodorovnú orientáciu potrubia pri pôsobení ohňa z vonka aj z vnútra potrubia. Izolácia sa k potrubiu prichytáva prostredníctvom navarovacích trňov (spotreba cca 20ks/m²). Na ukotvenie vrchnej dosky sa použijú oceľové vruty typu PROTECT SCREW. Pre kotvenie tesniacej upchávky k stene potrubia je nutné použiť vysokoteplotné lepidlo PROTECT BSK a následne zatmeliť tmelom BSF.

Hranaté potrubie (SLAB 4.0 Alu1):	Potrubie	EI 30S	EI 45S	EI 60S	EI 90S	EI 120S
Požiar z vonka	↔↕	50 mm	50 mm	70 mm	80 mm	80 mm
Požiar z vnútra / z vonka	↔↕	50 mm	70 mm	80 mm	80 mm	80 mm

Kruhové potrubie (WIRED MAT 4.0 Alu1)	Potrubie	EI 30S	EI 45S	EI 60S	EI 90S	EI 120S
Požiar z vonka	↔↕	50 mm	50 mm	50 mm	120 mm	120 mm
Požiar z vnútra / z vonka	↔↕	50 mm	70 mm	120 mm	120 mm	120 mm



FIRE PROTECT SCREW

Špeciálne vruty na vzájomné stiahnutie izolačných dosiek. Dĺžka vrutu by mala byť min. 2-násobok hrúbky použitej izolácie.

Dĺžka (mm)	ks / bal.	EUR/ks bez DPH	EUR/bal. bez DPH
100	500	0,600 €	300 €
140	500	0,800 €	400 €
160	200	1,150 €	230 €
200	200	1,250 €	250 €

CLIMAVER[®]
NOVÁ GENERÁCIA
VZDUCHOTECHNICKÉHO
POTRUBIA



DOSKY CLIMAVER

CLIMAVER® je izolované samonosné vzduchotechnické potrubie zabezpečujúce distribúciu upravovaného vzduchu pre účely vykurovania, vetrania a klimatizácie. Zaizolovaný vzduchotechnický kanál sa z jedného kusu materiálu vyrobí priamo na stavbe. Špeciálna úprava spojov VZT kanálov zaisťuje konštantný tlak v sieti potrubí s minimálnymi stratami. Vďaka zvukovej pohltivosti panelov už vo väčšine prípadov nie sú potrebné dodatočné tlmivé hluku.



CLIMAVER								
hr. izol. (mm)	Obj. kód	Rozmer (mm)	ks/bal.	m ² / bal.	m ² / pal.	EUR/ks bez DPH	EUR/m ² bez DPH	
25	Climaver PLUS R	KD 52296	3000 x 1190	7	24,99	299,88	146,37 €	41 €
25	Climaver NETO	KD 24424	3000 x 1190	7	24,99	299,88	157,08 €	44 €
25	Climaver A2 PLUS	KD 65229	3000 x 1190	6	21,42	299,88	185,64 €	52 €
25	Climaver A2 - NETO	KD 20300	3000 x 1190	6	21,42	299,88	192,78 €	54 €
40	Climaver APTA	KD 57316	3000 x 1210	5	18,15	199,65	188,76 €	52 €
40	Climaver A1 APTA	KD 69377	3000 x 1210	5	18,15	199,65	232,32 €	64 €
40	Climaver A2 APTA	KD 65228	3000 x 1210	5	18,15	199,65	254,10 €	70 €
25	Climaver A2 DECO - NEGRO (black)	KD 65237	3000 x 1190	7	24,99	149,94	224,91 €	63 €
25	Climaver A2 DECO - GRIS (Grey)	KD ...	3000 x 1190	7	24,99	149,94	235,62 €	66 €
25	Climaver A2 DECO - COLORS (*)	KD ...	3000 x 1190	7	24,99	149,94	249,90 €	70 €
40	Climaver STAR	KD 70757	3000 x 1210	1	3,63	65,34	446,49 €	123 €

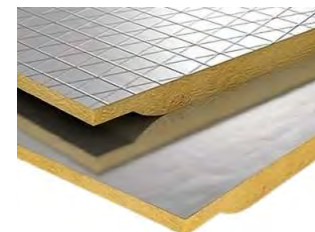

Príslušenstvo:

Položka	Popis	MJ	EUR/MJ bez DPH
CLIMAVER set v kufríku so 4 reznými nástrojmi / Universal tools KD 10370	Jeden kufrík so 4 nástrojmi (3 Climaver MM s redukciami pre panely CLIMAVER hr. 25 mm a 40 mm + 1 univerzálny MTR)	bal	1 203 €
CLIMAVER set v kufríku so 5 reznými nástrojmi / Tools KD 25706	Jeden kufrík s 5 nástrojmi (3 Climaver MM pre panely CLIMAVER hr. 25 mm + 2 MTR)	bal	1 203 €
CLIMAVER set v kufríku so 3 reznými nástrojmi / MM Tools KD 14	Jeden kufrík s 3 nástrojmi (support + blades)	bal	1 203 €
CLIMAVER APTA Tools KD 57756	Jeden kufrík pre panely Climaver hr. 40 mm	bal	1 203 €
CLIMAVER nôž / Knives KD 35177	Balenie 15 nožov, cena za 1ks	ks	29 €
CLIMAVER univerzálny uholník / Universal angle guide KD 10371	Balenie s 1 uhelníkom	ks	1 037 €
CLIMAVER sponkovačka / Stapler KD 30297	1 zošívacia v balení	ks	238 €
CLIMAVER páska / Tape (50 m x 63 mm x 50 μ) KD 16373	Balenie 12 hliníkových pásiiek (50 m x 63 mm x 50 μ)	ks	58 €
CLIMAVER NETO páska / Tape (50m x 63mm x 50μ) KD 24988	Balenie 12 Neto pásiiek	ks	66 €
CLIMAVER DECO páska / Tape (55mx63mm) Black/Grey KD	(*) Množstvo pásky je regulované podľa nákupu m ² CLIMAVER DECO	ks	160 €
CLIMAVER DECO páska / Tape (55mx63mm) Colors KD	(*) Množstvo pásky je regulované podľa nákupu m ² CLIMAVER DECO	ks	160 €
CLIMAVER STAR páska / Tape (50 m x 75mm) KD 69617	Balenie obsahuje 10 ks hliníkových pásiiek STAR (50 m x 75 mm)	ks	257 €
CLIMAVER lepidlo / Glue (1 Liter/bottle) KD 20736	Balenie obsahuje 12 ks lepidla	ks	27 €
CLIMAVER STAR lepidlo / Glue (310 ml/) KD 69917	Balenie obsahuje 12 ks lepidla	ks	27 €
PERFIVER L KD 17200	Hliníkový profil, 1 balenie s 80 ks (1,155 m/ks)	m	7 €
PERFIVER H KD 14302	Hliníkový profil pre panely CLIMAVER hr. 25 mm, 1 balenie s 20 ks (2,0 m/ks)	m	14 €
PERFIVER H 40 KD 10246	Hliníkový profil pre panely CLIMAVER hr. 40 mm, 1 balenie s 20 ks (2,0 m/ks)	m	19 €
CLIMAVER náhradné čepele / Case blades replacement KD 1004	1 balenie s 10 krabičkami (1 krabička obsahuje 20 ks náhradných čepeľí)	bal	1 224 €
CLIMAVER APTA 40 /case blades replacement KD 64996	1 balenie s 10 krabičkami (1 krabička obsahuje 20 ks náhradných čepeľí)	bal	1 426 €
CLIMAVER sponky / Staples KD 30298	Balenie obsahuje 5.000 ks svorek	bal	37 €
CLIMAVER stierka / Spatulas KD 30821	1 balenie obsahuje 18 stierok	bal	44 €

SKRUŽE s ALS fóliou "Combi"



Paroc HVAC Combi AluCoat T - Univerzálne vinuté puzdrá s ALS fóliou. Jedným typom skruže je možné zaizolovať väčší rozsah potrubí. Vnútorňý otvor hviezdicovitého prierezu umožňuje použiť jedno tepelnoizolačné puzdro na viac priemerov. Na strane ALS fólie nesmie teplota presiahnuť 80°C. Trieda reakcie na oheň A2-s1,d0.



HVAC

Vonk. Ø potr. (mm):	HVAC COMBI AluCoat T				HVAC COMBI AluCoat T				HVAC COMBI AluCoat T				HVAC COMBI AluCoat T			
	Hr. izolácie 20 mm				Hr. izolácie 30 mm				Hr. izolácie 40 mm				Hr. izolácie 50 mm			
	Obj, kód	bm/ bal.	bm/ pal.	EUR/bm bez DPH	Obj, kód	bm/ bal.	bm/ pal.	EUR/bm bez DPH	Obj, kód	bm/ bal.	bm/ pal.	EUR/bm bez DPH	Obj, kód	bm/ bal.	bm/ pal.	EUR/bm bez DPH
18	12/20 - 18/20	33,6	806,4	4,90 €	12/30 - 18/30	24	576	6,85 €	12/40 - 18/40	14,4	345,6	8,80 €	12/50 - 18/50	14,4	345,6	
28	22/20 - 28/20	24	576	5,55 €	22/30 - 28/30	18	432	7,95 €	22/40 - 28/40	10,8	259,2	9,75 €	22/50 - 28/50	10,8	259,2	12,25 €
38	32/20 - 38/20	18	432		32/30 - 38/30	14,4	345,6		32/40 - 38/40	8,4	235,2		32/50 - 38/50	8,4	235,2	
48	42/20 - 48/20	14,4	345,6		42/30 - 48/30	10,8	259,2		42/40 - 48/40	7,2	158,4		42/50 - 48/50	7,2	158,4	

SKRUŽE s ALS fóliou



Paroc HVAC Section AluCoat T - Vinuté izolačné puzdrá z minerálnej vlny s vystuženou AL fóliou a samolepiacim presahom. Dĺžka 1,2m. Max. prevádzková teplota 250°C, na strane ALS fólie nesmie teplota presiahnuť 80°C. Objemová hmotnosť 100kg/m³. Súčiniteľ tepelnej vodivosti λ10°C = 0,033 W/m.K. Trieda reakcie na oheň A2-s1,d0.



HVAC

Vonk. Ø potr. (mm):	HVAC Section AluCoat T				HVAC Section AluCoat T				HVAC Section AluCoat T				HVAC Section AluCoat T			
	Hr. izolácie 20 mm				Hr. izolácie 25 mm				Hr. izolácie 30 mm				Hr. izolácie 40 mm			
	Obj, kód	bm/ bal.	bm/ pal.	EUR/bm bez DPH	Obj, kód	bm/ bal.	bm/ pal.	EUR/bm bez DPH	Obj, kód	bm/ bal.	bm/ pal.	EUR/bm bez DPH	Obj, kód	bm/ bal.	bm/ pal.	EUR/bm bez DPH
15	15 / 20	42	1008	4,15 €	15 / 25	33,6	806,4	4,95 €	15 / 30	24	576	6,10 €	15 / 40	14,4	345,6	7,80 €
18	18 / 20	33,6	806,4	4,75 €	18 / 25	24	576	5,50 €	18 / 30	18	432	6,60 €	18 / 40	10,8	259,2	8,30 €
22	22 / 20	33,6	806,4	4,95 €	22 / 25	24	576	5,90 €	22 / 30	18	432	6,85 €	22 / 40	10,8	259,2	8,60 €
28	28 / 20	24	576	5,10 €	28 / 25	18	432	6,45 €	28 / 30	14,4	345,6	7,45 €	28 / 40	10,8	259,2	8,85 €
35	35 / 20	24	576	5,50 €	35 / 25	18	432	6,85 €	35 / 30	14,4	345,6	7,80 €	35 / 40	8,4	235,2	9,30 €
42	42 / 20	18	432	6,45 €	42 / 25	14,4	345,6	7,45 €	42 / 30	10,8	259,2	8,20 €	42 / 40	8,4	184,8	9,65 €
48	48 / 20	14,4	345,6	7,00 €	48 / 25	10,8	259,2	7,65 €	48 / 30	8,4	235,2	8,85 €	48 / 40	8,4	184,8	10,10 €
54	54 / 20	14,4	345,6	7,25 €	54 / 25	10,8	259,2	7,90 €	54 / 30	8,4	235,2	9,10 €	54 / 40	8,4	184,8	10,60 €
60	60 / 20	10,8	259,2	7,65 €	60 / 25	8,4	235,2	8,45 €	60 / 30	8,4	235,2	10,00 €	60 / 40	6	144	11,80 €
64	64 / 20	10,8	259,2	8,05 €	64 / 25	8,4	235,2	8,75 €	64 / 30	8,4	184,8	10,25 €	64 / 40	6	144	11,90 €
70	70 / 20	8,4	235,2	8,15 €	70 / 25	8,4	235,2	8,85 €	70 / 30	8,4	184,8	10,75 €	70 / 40	6	144	13,30 €
76	76 / 20	8,4	235,2	8,85 €	76 / 25	8,4	184,8	9,25 €	76 / 30	6	144	11,80 €	76 / 40	6	144	13,40 €
89	89 / 20	8,4	184,8	9,55 €	89 / 25	6	144	11,00 €	89 / 30	6	144	12,75 €	89 / 40	3,6	115,2	14,90 €
102					102 / 25	6	144	11,20 €	102 / 30	3,6	115,2	13,15 €	102 / 40	3,6	108	16,20 €
108					108 / 25	6	144	11,50 €	108 / 30	3,6	115,2	13,95 €	108 / 40	3,6	86,4	17,65 €
114					114 / 25	3,6	115,2	12,75 €	114 / 30	3,6	108	15,20 €	114 / 40	3,6	86,4	18,40 €
133					133 / 25	3,6	108	13,30 €	133 / 30	3,6	86,4	16,55 €	133 / 40	3,6	64,8	20,30 €
140					140 / 25	3,6	86,4	13,55 €	140 / 30	3,6	72	18,80 €	140 / 40	3,6	64,8	21,15 €
159					159 / 25	3,6	72	15,65 €	159 / 30	3,6	64,8	19,50 €	159 / 40	2,4	52,8	22,60 €
168					168 / 25	3,6	64,8	18,65 €	168 / 30	3,6	57,6	20,40 €	168 / 40	2,4	52,8	23,20 €
194													194 / 40	2,4	43,2	27,20 €
208									208 / 30	2,4	43,2	24,15 €	208 / 40	2,4	38,4	28,85 €
219									219 / 30	2,4	38,4	26,90 €	219 / 40	2,4	38,4	32,25 €



Paroc HVAC Section AluCoat T - Vinuté izolačné puzdrá z minerálnej vlny s vystuženou AL fóliou a samolepiacim presahom. Dĺžka 1,2m. Max. prevádzková teplota 250°C, na strane ALS fólie nesmie teplota presiahnúť 80°C. Objemová hmotnosť 100kg/m³. Súčiniteľ tepelnej vodivosti λ10°C = 0,033 W/m.K.



HVAC

Vonk. Ø potr. (mm):	HVAC Section AluCoat T				HVAC Section AluCoat T				HVAC Section AluCoat T				HVAC Section AluCoat T			
	Hr. izolácie 50 mm				Hr. izolácie 60 mm				Hr. izolácie 70 mm				Hr. izolácie 80 mm			
	Obj. kód	bm/ bal.	bm/ pal.	EUR/bm bez DPH	Obj. kód	bm/ bal.	bm/ pal.	EUR/bm bez DPH	Obj. kód	bm/ bal.	bm/ pal.	EUR/bm bez DPH	Obj. kód	bm/ bal.	bm/ pal.	EUR/bm bez DPH
18	18 / 50	8,4	235,2	10,35 €	18 / 60	6	144	12,20 €								
22	22 / 50	8,4	184,8	11,05 €	22 / 60	6	144	12,60 €	22 / 70	3,6	108	15,15 €	22 / 80	3,6	72	16,90 €
28	28 / 50	8,4	184,8	11,65 €	28 / 60	6	144	12,50 €	28 / 70	3,6	108	16,50 €	28 / 80	3,6	64,8	19,80 €
35	35 / 50	6	144	12,05 €	35 / 60	6	144	13,70 €	35 / 70	3,6	108	17,85 €	35 / 80	3,6	64,8	21,95 €
42	42 / 50	6	144	12,60 €	42 / 60	3,6	115,2	14,75 €	42 / 70	3,6	108	19,20 €	42 / 80	3,6	64,8	22,50 €
48	48 / 50	6	144	13,40 €	48 / 60	3,6	115,2	15,60 €	48 / 70	3,6	86,4	20,15 €	48 / 80	3,6	72	23,35 €
54	54 / 50	6	144	13,70 €	54 / 60	3,6	108	16,90 €	54 / 70	3,6	86,4	21,75 €	54 / 80	3,6	64,8	24,25 €
60	60 / 50	6	144	14,65 €	60 / 60	3,6	108	18,65 €	60 / 70	3,6	72	22,95 €	60 / 80	3,6	64,8	25,55 €
64	64 / 50	3,6	115,2	15,10 €	64 / 60	3,6	108	19,05 €	64 / 70	3,6	72	23,60 €	64 / 80	3,6	64,8	25,95 €
70	70 / 50	3,6	115,2	15,85 €	70 / 60	3,6	86,4	19,90 €	70 / 70	3,6	72	24,15 €	70 / 80	3,6	57,6	26,80 €
76	76 / 50	3,6	108	17,30 €	76 / 60	3,6	86,4	20,40 €	76 / 70	3,6	64,8	24,85 €	76 / 80	3,6	57,6	29,85 €
89	89 / 50	3,6	86,4	18,65 €	89 / 60	3,6	72	23,05 €	89 / 70	3,6	57,6	27,70 €	89 / 80	2,4	52,8	31,10 €
102	102 / 50	3,6	72	18,80 €	102 / 60	3,6	64,8	23,60 €	102 / 70	2,4	52,8	29,40 €	102 / 80	2,4	48	32,80 €
108	108 / 50	3,6	72	19,05 €	108 / 60	3,6	57,6	25,25 €	108 / 70	2,4	52,8	32,15 €	108 / 80	2,4	43,2	34,40 €
114	114 / 50	3,6	64,8	20,60 €	114 / 60	3,6	57,6	26,65 €	114 / 70	2,4	48	33,65 €	114 / 80	2,4	43,2	37,85 €
133	133 / 50	3,6	57,6	22,40 €	133 / 60	2,4	48	29,10 €	133 / 70	2,4	43,2	35,35 €	133 / 80	2,4	38,4	39,90 €
140	140 / 50	2,4	52,8	26,80 €	140 / 60	2,4	48	31,35 €	140 / 70	2,4	38,4	35,90 €	140 / 80	2,4	38,4	41,40 €
159	159 / 50	2,4	48	29,70 €	159 / 60	2,4	38,4	33,25 €	159 / 70	2,4	38,4	38,35 €	159 / 80	1,2	31,2	45,25 €
168	168 / 50	2,4	43,2	30,65 €	168 / 60	2,4	38,4	34,40 €	168 / 70	1,2	38,4	39,20 €	168 / 80	1,2	31,2	46,25 €
194	194 / 50	2,4	38,4	34,10 €	194 / 60	1,2	38,4	36,00 €	194 / 70	1,2	28,8	44,30 €	194 / 80	1,2	24	51,20 €
208	208 / 50	1,2	38,4	35,25 €	208 / 60	1,2	31,2	37,45 €	208 / 70	1,2	24	52,50 €	208 / 80	1,2	21,6	54,80 €
219	219 / 50	1,2	31,2	38,70 €	219 / 60	1,2	28,8	43,65 €	219 / 70	1,2	21,6	57,30 €	219 / 80	1,2	21,6	60,30 €
259	259 / 50	1,2	21,6	43,65 €	259 / 60	1,2	21,6	45,25 €	259 / 70	1,2	21,6	59,75 €	259 / 80	1,2	19,2	63,50 €
273	273 / 50	1,2	21,6	45,25 €	273 / 60	1,2	21,6		273 / 70	1,2	19,2		273 / 80	1,2	19,2	71,70 €

IZOLAČNÉ VÝROBKY PRE HVAC/TZB IZOLÁCIE



Systémy izolácií HVAC/TZB v novodobých stavbách plnia niekoľko funkcií. Používajú sa na potrubné rozvody teplej a studenej vody, kúrenia alebo pre vzduchotechnické a klimatizačné kanály. Systém musí byť zaizolovaný tak, aby sa zaistili dobré tepelnoizolačné vlastnosti a tam kde sa to vyžaduje mal aj akustickú izoláciu. Ďalšou kľúčovou úlohou je zabrániť vzniku kondenzácie vzdušnej vlhkosti, ktorá spôsobuje koróziu materiálov, farebné škvrny a znižuje účinnosť tepelnej izolácie.



PAROC®



Paroc HVAC Section AluCoat T - Vinuté izolačné puzdrá z minerálnej vlny s vystuženou AL fóliou a samolepiacim presahom. Dĺžka 1,2m. Max. prevádzková teplota 250°C, na strane ALS fólie nesmie teplota presiahnuť 80°C. Objemová hmotnosť 100kg/m³. Súčiniteľ tepelnej vodivosti λ_{10°C} = 0,034 W/m.K.

Vonk. Ø potr. (mm):	HVAC Section AluCoat T				HVAC Section AluCoat T				HVAC Section AluCoat T				HVAC Section AluCoat T			
	Hr. izolácie 90 mm				Hr. izolácie 100 mm				Hr. izolácie 110 mm				Hr. izolácie 120 mm			
	Obj. kód	bm/ bal.	bm/ pal.	EUR/bm bez DPH	Obj. kód	bm/ bal.	bm/ pal.	EUR/bm bez DPH	Obj. kód	bm/ bal.	bm/ pal.	EUR/bm bez DPH	Obj. kód	bm/ bal.	bm/ pal.	EUR/bm bez DPH
35	35 / 90	3,6	64,8		35 / 100	3,6	57,6	26,40 €								
42	42 / 90	3,6	64,8	23,70 €												
48	48 / 90	3,6	57,6	26,15 €												
54	54 / 90	3,6	57,6	26,00 €	54 / 100	2,4	48	32,45 €								
60	60 / 90	2,4	52,8	29,10 €	60 / 100	2,4	48	34,40 €								
64	64 / 90	2,4	52,8	29,95 €	64 / 100	2,4	48	35,75 €	64 / 110	2,4	38,4		64 / 120	2,4	76,8	45,00 €
70	70 / 90	2,4	52,8	31,00 €	70 / 100	2,4	43,2	38,35 €	70 / 110	2,4	38,4		70 / 120	2,4	76,8	
76	76 / 90	2,4	48	31,45 €	76 / 100	2,4	43,2	39,10 €	76 / 110	2,4	38,4		76 / 120	2,4	76,8	48,00 €
89	89 / 90	2,4	43,2	33,60 €	89 / 100	2,4	38,4	42,90 €	89 / 110	1,2	38,4		89 / 120	1,2	31,2	49,80 €
102	102 / 90	2,4	38,4	35,05 €	102 / 100	2,4	38,4	45,00 €	102 / 110	1,2	31,2		102 / 120	1,2	28,8	
108	108 / 90	2,4	38,4	35,75 €	108 / 100	1,2	38,4	48,60 €	108 / 110	1,2	31,2	50,95 €	108 / 120	1,2	24	54,80 €
114	114 / 90	2,4	38,4	38,00 €	114 / 100	1,2	38,4	50,55 €	114 / 110	1,2	28,8	53,70 €	114 / 120	1,2	24	56,90 €
133	133 / 90	1,2	38,4	39,75 €	133 / 100	1,2	28,8	53,30 €	133 / 110	1,2	24	55,10 €	133 / 120	1,2	21,6	61,60 €
140	140 / 90	1,2	31,2	43,50 €	140 / 100	1,2	28,8	55,75 €	140 / 110	1,2	21,6	57,30 €	140 / 120	1,2	21,6	64,30 €
159	159 / 90	1,2	28,8	45,40 €	159 / 100	1,2	21,6	60,60 €	159 / 110	1,2	21,6	62,00 €	159 / 120	1,2	21,6	66,25 €
168	168 / 90	1,2	24	49,15 €	168 / 100	1,2	21,6	62,25 €	168 / 110	1,2	21,6	64,05 €	168 / 120	1,2	19,2	72,70 €
194	194 / 90	1,2	21,6	53,55 €	194 / 100	1,2	21,6	67,05 €	194 / 110	1,2	19,2					
208	208 / 90	1,2	21,6	55,50 €	208 / 100	1,2	19,2	70,50 €	208 / 110	1,2	19,2					
219	219 / 90	1,2	21,6	62,10 €	219 / 100	1,2	19,2	72,60 €	219 / 110	1,2	36	91,80 €	219 / 120	1,2	33,6	98,30 €
259	259 / 90	1,2	36		259 / 100	1,2	33,6	89,80 €	259 / 110	1,2	26,4		259 / 120	1,2	24	
273	273 / 90	1,2	33,6		273 / 100	1,2	26,4	99,50 €	273 / 110	1,2	24		273 / 120	1,2	24	

LAMELOVÉ PÁSY HVAC s AL fóliou

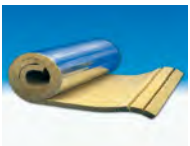

Lamelový izolačný pás z čadičovej vlny nalepený na hliníkovú fóliu s vystuženou sklotextilnou mriežkou.

PAROC HVAC Lamella Mat AluCoat (35kg/m3)				PAROC HVAC Lamella Mat AluCoat FIX				PAROC HVAC Mat AluCoat			
hr. (mm)	EUR/m2 bez DPH	m ² / bal.	m ² / pal.	hr. (mm)	EUR/m2 bez DPH	m ² / bal.	m ² / pal.	hr. (mm)	EUR/m2 bez DPH	m ² / bal.	m ² / pal.
20	9,70 €	10	250	20	11,55 €	10	250				
25	9,85 €	8	200								
30	10,00 €	8	200	30	12,90 €	8	200	30		8	168
40	11,60 €	6	150	40	14,35 €	6	150	40	9,00 €	7	147
50	13,50 €	5	125	50	16,20 €	5	125	50	10,45 €	7	147
60	16,25 €	4	100	60	18,60 €	4	100	60		7	147
80	22,00 €	3	75	80	23,25 €	3	75	80	17,30 €	5	105
100	27,45 €	2,5	60	100	27,65 €	2,5	60	100		4	84

Max.250°C. Šírka 1m.

So samolepom. Šírka 1m.

Max.350°C. Šírka 1m.

DOSKY HVAC



Izolačné dosky vyrobené z kamennej vlny sú určené k tepelnej a akustickej izolácií.

PAROC HVAC SLAB				PAROC HVAC SLAB Alu			
hr. (mm)	EUR/m2 bez DPH	m ² / bal.	m ² / pal.	hr. (mm)	EUR/m2 bez DPH	m ² / bal.	m ² / pal.
50		5,76	69,12	50		5,76	69,12
100		3,6	36	100		3,6	36

Rozmery:0,6 x 1,2m. (alt.1,2x2m)

Rozmery:0,6 x 1,2m. (alt.1,2x2m)

DOSKY HVAC s netkanou sklenou textíliou



N1- doska z jednej strany kaširovaná netkanou sklenou textíliou bielej farby.

N3- doska z jednej strany kaširovaná netkanou sklenou textíliou čiernej farby.

HVAC SLAB 60 N1				InVent 60 N3				InVent 80 N3 alebo N1			
hr. (mm)	EUR/m2 bez DPH	ks/ pal.	m ² / pal.	hr. (mm)	EUR/m2 bez DPH	ks/ pal.	m ² / pal.	hr. (mm)	EUR/m2 bez DPH	ks/ pal.	m ² / pal.
50		48	115,2	50	17,20 €	24	57,6	15		80	192
100		24	57,6	100	28,70 €	12	28,8	30		40	96
								50		24	57,6
								100		12	28,8

Rozmery:2 x 1,2m.(alt. 0,6x1,2m)

Rozmery:2 x 1,2m.(alt. 0,6x1,2m)

Rozmery:2 x 1,2m.(alt. 0,6x1,2m)

DOSKY HVAC s tkanou sklenou textíliou



G9 - doska z jednej strany kaširovaná antibakteriálnou tkanou sklenou textíliou čiernej farby.

InVent 40 G9				InVent 60 G9				InVent 80 G9			
hr. (mm)	EUR/m2 bez DPH	ks/ pal.	m ² / pal.	hr. (mm)	EUR/m2 bez DPH	ks/ pal.	m ² / pal.	hr. (mm)	EUR/m2 bez DPH	ks/ pal.	m ² / pal.
-		-	-	30	14,35 €	40	96	30		40	96
50		24	57,6	50	29,05 €	24	57,6	50		24	57,6
100		12	28,8	100		12	28,8	100		12	28,8

Rozmery:2 x 1,2m.

Rozmery:2 x 1,2m.

Rozmery:2 x 1,2m.

PÁSY PAROC PRO LAMELLA MAT

Lamelové pásy s AL fóliou.



PAROC PRO Lamella Mat AluCoat (50kg/m ³)			
hr. (mm)	EUR/m ² bez DPH	m ² / bal.	m ² / pal.
20	11,85 €	10	250
30	12,75 €	8	200
40	15,85 €	6	150
50	18,05 €	5	125
60	19,80 €	4	100
80	29,55 €	3	75
100	36,35 €	2,5	62,5

Max.500°C. Šírka 1m.

Lamelové pásy s UV odolným povrchom.

PAROC PRO Lamella Mat CLAD (50kg/m ³)			
hr. (mm)	EUR/m ² bez DPH	m ² / bal.	m ² / pal.
40	29,80 €	6	-
60		2,4	-
80	58,35 €	2,4	-

Max.500°C. Šírka 1m.

PÁSY PAROC PRO MAT

Izolačné pásy s pozdĺžnym vláknom.



PAROC PRO Mat WR350 (50kg/m ³)				PAROC PRO Mat WR350 AluCoat (50kg/m ³)				PAROC PRO Mat WR640 (80kg/m ³)				PAROC PRO Mat 100 (100kg/m ³)			
hr. (mm)	EUR/m ² bez DPH	m ² / bal.	m ² / pal.	hr. (mm)	EUR/m ² bez DPH	m ² / bal.	m ² / pal.	hr. (mm)	EUR/m ² bez DPH	m ² / bal.	m ² / pal.	hr. (mm)	EUR/m ² bez DPH	m ² / bal.	m ² / pal.
40	8,60 €	7	147	40	9,65 €	7	147	40	10,85 €	6,5	136,5	40	14,95 €	6,5	136,5
50	9,15 €	6,5	136,5	50	11,10 €	6,5	136,5	50	11,35 €	5	105	50	15,20 €	4,5	94,5
80	15,75 €	5	105	60	13,60 €	6	126	60	13,75 €	4	84	60	17,55 €	4	84
100	20,20 €	4	84	100	22,05 €	4	84	80	18,45 €	3	63	100	28,90 €	2	42

Max.350°C. Šírka 1m.

Max.350°C. Šírka 1m.

Max.550°C. Šírka 1m.

Max.550°C. Šírka 1m.

ROHOŽE PAROC PRO WIRED MAT - na drôtenom pletive

Izolačné rohože s pozinkovaným šesťhranným drôteným pletivom.



PAROC PRO Wired Mat WR660 (80kg/m ³)				PAROC PRO Wired Mat WR660 AL1 (80kg/m ³)				PAROC PRO Wired Mat WR680 (100kg/m ³)				PAROC PRO Wired Mat WR700 (130kg/m ³)			
hr. (mm)	EUR/m ² bez DPH	m ² / bal.	m ² / pal.	hr. (mm)	EUR/m ² bez DPH	m ² / bal.	m ² / pal.	hr. (mm)	EUR/m ² bez DPH	m ² / bal.	m ² / pal.	hr. (mm)	EUR/m ² bez DPH	m ² / bal.	m ² / pal.
30	12,70 €	8	168	30	21,50 €	8	168	30	14,15 €	8	168	50	25,80 €	4,5	94,5
40	17,00 €	6,5	136,5	40	22,40 €	6,5	136,5	40	19,55 €	6,5	136,5	60	31,95 €	4	84
50	19,80 €	5	105	50	26,75 €	5	105	50	23,95 €	4,5	94,5	80	46,60 €	3	63
60	22,10 €	4	84	60	28,95 €	4	84	60	28,05 €	4	84	100	51,70 €	2	42
70	26,75 €	3,5	73,5	80	36,05 €	3,5	73,5	70	34,05 €	3,5	73,5				
80	29,25 €	3,5	73,5	100	44,05 €	2,5	52,5	80	36,75 €	3,5	73,5				
90	32,80 €	3	63	120	52,70 €	2	42	100	40,35 €	2,5	52,5				
100	37,20 €	2,5	52,5					120	43,45 €	2	42				
120	39,20 €	2	42												

Max.660°C. Šírka 1m.

Max.660°C. Šírka 1m.

Max.680°C. Šírka 1m.

Max.680°C. Šírka 1m.

HEATROCK PS (ROCKWOOL 800)

Potrúbné puzdro z nehorľavej kamennej vlny pre izoláciu rozvodov tepla a teplej vody, centrálného vykurovania a ďalších zariadení



ÚSPORY TEPLA PRI POUŽITÍ POTRUBNÉHO PUZDRA ROCKWOOL 800

vnútorný priemer potrubného puzdra [mm]	hrúbka izolačnej vrstvy [mm]							
	20	30	40	50	60	70	80	100
15	75 %	79 %						
18	77 %	80 %						
22	78 %	81 %	84 %					
28	79 %	83 %	85 %	86 %				
35	80 %	84 %	86 %	87 %				
42	81 %	84 %	86 %	88 %	89 %			
48	81 %	85 %	87 %	88 %	89 %			
54	81 %	85 %	87 %	89 %	90 %			
60	82 %	85 %	88 %	89 %	90 %			
64	82 %	86 %	88 %	89 %	90 %			
70		86 %	88 %	89 %	90 %	91 %		
76		86 %	88 %	89 %	90 %	91 %		
89		86 %	88 %	90 %	91 %	92 %	92 %	
108		86 %	89 %	90 %	91 %	92 %	93 %	93 %
114		87 %	89 %	90 %	91 %	92 %	93 %	93 %
133		87 %	89 %	90 %	91 %	92 %	93 %	94 %
140		87 %	89 %	90 %	91 %	92 %	93 %	94 %
159				91 %	92 %	92 %	93 %	94 %
169				91 %	92 %	92 %	93 %	94 %

Výpočty boli vykonané pre teplotu média 55 °C a teplotu okolia 18 °C.

Úspora je rozdiel medzi neizolovaným potrubím a potrubím zaizolovaným pomocou puzdier ROCKWOOL 800.

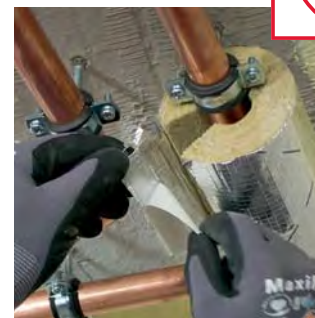

www.rockwool.sk



HEATROCK PS (Rockwool 800) je nehorľavé puzdro z kamennej vlny s nalepenou hliníkovou fóliou vystuženou sklenenou mriežkou. Puzdro má na pozdĺžnom spoji presah fólie so samolepiacou páskou. Dĺžka 1m. Max. prevádzková teplota 250°C. Objemová hmotnosť 100kg/m3. Súčiniteľ tepelnej vodivosti $\lambda_{10^\circ\text{C}} = 0,033 \text{ W/m.K}$. Trieda reakcie na oheň A2-s1,d0.

Vonk. Ø potr. (mm):	HEATROCK PS (Rockwool 800)				HEATROCK PS (Rockwool 800)				HEATROCK PS (Rockwool 800)				HEATROCK PS (Rockwool 800)			
	Hr. izolácie 20 mm				Hr. izolácie 30 mm				Hr. izolácie 40 mm				Hr. izolácie 50 mm			
	Obj. kód	bm/ bal.	bm/ pal.	EUR/bm bez DPH	Obj. kód	bm/ bal.	bm/ pal.	EUR/bm bez DPH	Obj. kód	bm/ bal.	bm/ pal.	EUR/bm bez DPH	Obj. kód	bm/ bal.	bm/ pal.	EUR/bm bez DPH
15	15 / 20	48	576	4,30 €	15 / 30	25	300	5,30 €	15 / 40	16	144	7,90 €				
18	18 / 20	42	504	4,50 €	18 / 30	25	300	5,70 €	18 / 40	12	108	8,40 €				
22	22 / 20	36	432	5,10 €	22 / 30	20	240	6,10 €	22 / 40	13	156	8,70 €	22 / 50	9	81	14,10 €
28	28 / 20	30	360	5,40 €	28 / 30	20	240	6,50 €	28 / 40	12	144	8,90 €	28 / 50	9	81	14,90 €
35	35 / 20	25	300	5,90 €	35 / 30	16	192	6,90 €	35 / 40	9	108	9,50 €	35 / 50	7	84	16,00 €
42	42 / 20	20	240	6,10 €	42 / 30	12	144	7,50 €	42 / 40	9	108	9,80 €	42 / 50	6	72	16,40 €
48	48 / 20	16	192	6,30 €	48 / 30	12	144	7,90 €	48 / 40	9	108	10,30 €	48 / 50	6	72	17,30 €
54	54 / 20	16	192	6,70 €	54 / 30	10	120	8,40 €	54 / 40	8	96	11,10 €	54 / 50	5	60	17,60 €
60	60 / 20	12	144	8,10 €	60 / 30	9	108	10,10 €	60 / 40	6	72	13,80 €	60 / 50	5	60	18,40 €
64	64 / 20	12	144	9,30 €	64 / 30	9	108	11,20 €	64 / 40	6	72	16,00 €	64 / 50	4	48	20,00 €
70					70 / 30	8	96	14,10 €	70 / 40	5	60	18,10 €	70 / 50	4	48	26,10 €
76					76 / 30	7	84	14,90 €	76 / 40	5	60	18,80 €	76 / 50	4	48	26,80 €
89					89 / 30	6	72	16,00 €	89 / 40	4	48	20,00 €	89 / 50	-	33	28,00 €
108					108 / 30	4	48	18,80 €	108 / 40	-	33	24,00 €	108 / 50	-	27	32,00 €
114					114 / 30	4	48	20,00 €	114 / 40	-	32	25,20 €	114 / 50	-	25	33,20 €
133					133 / 30	-	32	21,20 €	133 / 40	-	25	26,40 €	133 / 50	-	24	34,40 €
140					140 / 30	-	30	22,40 €	140 / 40	-	24	27,60 €	140 / 50	-	20	35,60 €
159													159 / 50	-	16	38,00 €
168													168 / 50	-	16	40,00 €
Vonk. Ø potr. (mm):	HEATROCK PS (Rockwool 800)				HEATROCK PS (Rockwool 800)				HEATROCK PS (Rockwool 800)				HEATROCK PS (Rockwool 800)			
	Hr. izolácie 60 mm				Hr. izolácie 70 mm				Hr. izolácie 80 mm				Hr. izolácie 100 mm			
	Obj. kód	bm/ bal.	bm/ pal.	EUR/bm bez DPH	Obj. kód	bm/ bal.	bm/ pal.	EUR/bm bez DPH	Obj. kód	bm/ bal.	bm/ pal.	EUR/bm bez DPH	Obj. kód	bm/ bal.	bm/ pal.	EUR/bm bez DPH
60	60 / 60	4	48	28,90 €												
64	64 / 60	-	36	29,60 €												
70	70 / 60	-	33	30,80 €	70 / 70		26	33,10 €								
76	76 / 60	-	30	31,60 €	76 / 70	-	25	33,80 €	76 / 80	-	20	40,80 €				
89	89 / 60	-	27	32,80 €	89 / 70		22	34,90 €	89 / 80	-	19	42,00 €	89 / 100	-	12	64,00 €
108	108 / 60	-	23	36,80 €	108 / 70	14,1	19	36,00 €	108 / 80	-	16	43,20 €	108 / 100	-	11	65,20 €
114	114 / 60	-	20	38,00 €	114 / 70	-	17	39,70 €	114 / 80	-	15	47,20 €	114 / 100	-	11	68,80 €
133	133 / 60	-	17	39,20 €	133 / 70	-	15	40,80 €	133 / 80	-	12	52,00 €	133 / 100	-	10	74,00 €
140	140 / 60	-	16	42,00 €	140 / 70	-	14	43,30 €	140 / 80	-	12	56,00 €	140 / 100	-	9	78,00 €
159	159 / 60	-	14	52,00 €	159 / 70	-	12	49,60 €	159 / 80	-	11	58,00 €	159 / 100	-	8	79,90 €
168	168 / 60	-	12	56,00 €	168 / 70	-	11	53,30 €	168 / 80	-	10	62,00 €	168 / 100	-	8	84,00 €
194													194 / 100	-	6	91,90 €
219													219 / 100	-	6	139,90 €
273													273 / 100	-	5	159,80 €

LAMELOVÉ PÁSY s ALS fóliou , samolepiace



KLIMAFIX			
hr. (mm)	EUR/m2 bez DPH	m ² / bal.	m ² / pal.
20	11,40 €	10	240
30	13,90 €	8	192
40	17,10 €	6	144
50	19,50 €	5	120

Max.50°C. Šírka 1m.

LAMELOVÉ PÁSY s ALS fóliou

Lamelový izolačný pás z čadičovej vlny nalepený na hliníkovú fóliu vystuženú sklotextilnou mriežkou.



KLIMAMAT (Larock 40 ALS)			
hr. (mm)	EUR/m2 bez DPH	m ² / bal.	m ² / pal.
20	6,70 €	10	240
30	7,70 €	8	192
40	9,40 €	6	144
50	10,50 €	5	120
60	12,70 €	4	96
80	14,90 €	3	72
100	18,70 €	2,5	60

Max.250°C. Šírka 1m.

DOSKY s hliníkovou fóliou "ALS"



Techrock 40 ALS				Techrock 60 ALS				Techrock 80 ALS			
hr. (mm)	EUR/m2 bez DPH	m ² / bal.	m ² / pal.	hr. (mm)	EUR/m2 bez DPH	m ² / bal.	m ² / pal.	hr. (mm)	EUR/m2 bez DPH	m ² / bal.	m ² / pal.
40	12,10 €	9	72	40	16,00 €	7,2	72	40	17,60 €	7,2	72
60		6	48	60	22,40 €	4,8	48	60	27,60 €	4,8	48
80		4,8	38,4	80		3,6	36	80	35,30 €	3,6	36

Max.250°C. Rozmery 0,6 x 1m.

Max.250°C. Rozmery 0,6 x 1m.

Max.250°C. Rozmery 0,6 x 1m.

DOSKY s čiernou netkanou sklotextiliou "FB1"



Techrock 40 FB1				Techrock 60 FB1				Techrock 100 FB2			
hr. (mm)	EUR/m2 bez DPH	ks/ pal.	m ² / pal.	hr. (mm)	EUR/m2 bez DPH	ks/ pal.	m ² / pal.	hr. (mm)	EUR/m2 bez DPH	m ² / bal.	m ² / pal.
50	13,00 €	48	57,6	40		30	72	60		2,5	40
				50	17,60 €	24	57,6				
				60		20	48				
				80		15	36				
				100	27,50 €	12	28,8				

Max.400°C. Rozmery 1,2 x 1m.

Rozmery 1, x 0,5m.

Max.560°C. Rozmery 1,2 x 2m.

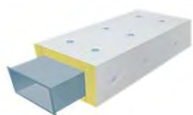

TECHROCK 60 ALS			
hr. (mm)	EUR/m2 bez DPH	m ² / bal.	m ² / pal.
40	16,00 €	7,2	72

TECHROCK 80 ALS			
hr. (mm)	EUR/m2 bez DPH	m ² / bal.	m ² / pal.
40	17,60 €	7,2	72
60	27,60 €	4,8	48

Rozmery 0,6x1m.

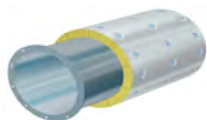

LAROCK 65 ALS			
hr. (mm)	EUR/m2 bez DPH	m ² / bal.	m ² / pal.
40	17,20 €	5	60

Šírka 1m.

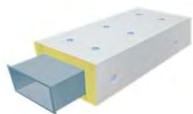

CONLIT PLUS 60 ALU			
hr. (mm)	EUR/m2 bez DPH	m ² / bal.	m ² / pal.
60	54,40 €	-	30 (24)

Rozmery 1,2 x 1 m

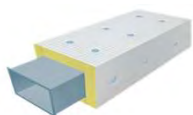

CONLIT PLUS 120 ALU			
hr. (mm)	EUR/m2 bez DPH	m ² / bal.	m ² / pal.
60	61,10 €	-	30 (24)

Rozmery 1,2 x 1 m

PYROROCK - systém protipožiarnej ochrany VZT 30, 45, 60 min.

Systém požiarnej odolnosti hranatého VZT potrubia sa skladá z izolačných dosiek Techrock ALS pre požiarneho systému, navarovacích trňov pre ukotvenie izolácie a pásky ALS na prelepenie spojov. Systém zaisťuje požiarne odolnosť pre vodorovné alebo zvislé potrubie: E45 a EI 45, prípadne E 60 a EI 60.

Hranaté potrubie (TECHROCK 60 ALS):	Potrubie	E 45 /EI 45	
Požiar z vonka	↔	40 mm	-

Hranaté potrubie (TECHROCK 80 ALS):	Potrubie	E 60/ EI 60	
Požiar z vonka	↕		40 mm
Požiar z vonka	↔		60 mm

PYROROCK - systém protipožiarnej ochrany VZT EI 30, 45, 60 min.

Systém požiarnej odolnosti kruhového VZT potrubia sa skladá z izolačnej rohože Larock 65 ALS, navarovacích trňov s klobúčikmi pre ukotvenie izolácie a pásky ALS na prelepenie spojov. Pri priemere potrubia nad 500 mm je nutné oviniť vodorovné potrubie šesťhranným pletivom s ukotvením na trne. Systém zaisťuje požiarne odolnosť pre vodorovné alebo zvislé potrubie EI 45 S a E 60 S.

Kruhové potrubie (LAROCK 65ALS):	Potrubie	EI 45 S	E 60 S
Požiar z vonka	↕	40 mm	40 mm
Požiar z vonka	↔	40 mm	40 mm

CONLIT PLUS - systém protipožiarnej ochrany VZT EI 60 a 120 min.

Systém ochrany pravouhlého vzduchotechnického potrubia proti požiaru z vonka aj z vnútra sa skladá z dosiek Conlit Plus 60 a Conlit Plus 120 a navarovacích trňov. Všetky spoje izolačných dosiek sa zaisťujú pomocou lepidla Conlit Fix a prelepujú sa ALS páskou.

Hranaté potrubie (CONLIT DUCTROCK):	Potrubie	Izolácia:	EI 60 S	EI 120S
Požiar z vnútra / z vonka	↔ ↕	CD 60	60 mm	
Požiar z vnútra / z vonka	↔ ↕	CD 120		60 mm

Hranaté potrubie (CONLIT DUCTROCK):	Potrubie	Izolácia:	EI 60 S 500 multi
Potrubie max.rozmerov 1,25 x 1m	↔ ↕	CD 60	60 mm

Príslušenstvo k systémom CONLIT DUCTROCK:

Conlit FIX

Systémové lepidlo na spojovanie a lepenie dosiek CONLIT DUCTROCK.
Spotreba 0,5 kg/m² izolácie pri nanosení 2mm.

kg / bal.	EUR/kg bez DPH	EUR/bal. bez DPH
20	8,40 €	168,00 €

SYSTÉM NEHORĽAVEJ IZOLÁCIE ROZVODOV CHLADENIA - TECLIT



HVAC



TECLIT PS je nehorľavé puzdro z kamennej vlny s pevnou hliníkovou fóliou a samolepiacim presahom, vhodné na izolovanie rozvodov chladenia a studenej vody v budovách. Systém chráni potrubie pred koróziou a vznikom kondenzácie. Dĺžka 1m. Prevádzková teplota od 0°C do 250°C, na strane ALS fólie 80°C. Faktor difúzneho odporu $\mu > 10\ 000$. Súčiniteľ tepelnej vodivosti $\lambda_{10^\circ\text{C}} = 0,033\ \text{W/m.K}$. Trieda reakcie na oheň A2-s1,d0.

TECLIT HA chladové izolačné závesy do systému TECLIT (dodávané bez kovovej objímky)



Vonk. Ø potr. (mm):	TECLIT PS Cold				Iz. záves TECLIT HA		
	Obj, kód	bm/ bal.	bm/ pal.	EUR/bm bez DPH	Obj, kód	ks/ bal.	EUR/ks bez DPH
Hr. izolácie 20 mm							
15	15 / 20	48	576	5,40 €	15 / 20	252	7,65 €
18	18 / 20	42	504	6,30 €	18 / 20	160	8,30 €
22	22 / 20	36	432	5,15 €	22 / 20	192	8,35 €
28	28 / 20	30	360	5,15 €	28 / 20	160	8,50 €
35	35 / 20	25	300	6,45 €	35 / 20	120	9,30 €
42	42 / 20	20	240	6,70 €	42 / 20	112	9,70 €
48	48 / 20	16	192	10,30 €	48 / 20	80	9,30 €
Hr. izolácie 30 mm							
22	22 / 30	20	240	10,05 €	22 / 30	96	9,50 €
28	28 / 30	20	240	10,70 €	28 / 30	80	10,10 €
35	35 / 30	16	192	11,10 €	35 / 30	80	10,15 €
42	42 / 30	12	144	14,25 €	42 / 30	60	10,30 €
48	48 / 30	12	144	14,35 €	48 / 30	60	10,55 €
54	54 / 30	10	120	16,10 €	54 / 30	54	11,40 €
60	60 / 30	9	108	16,50 €	60 / 30	48	12,15 €
64	64 / 30	9	108	17,80 €	64 / 30	48	13,05 €
76	76 / 30		84	19,75 €	76 / 30	38	13,50 €
89	89 / 30		72	22,95 €	89 / 30		13,70 €
Hr. izolácie 40 mm							
35	35 / 40	9	108	16,50 €	35 / 40	48	11,30 €
42	42 / 40	9	108	17,40 €	42 / 40	48	11,85 €
48	48 / 40	9	108	18,25 €	48 / 40	44	11,30 €
54	54 / 40	8	96	19,75 €	54 / 40	38	12,35 €
60	60 / 40	6	72	23,35 €	60 / 40		13,25 €
64	64 / 40	6	72	24,45 €	64 / 40	26	13,35 €
76	76 / 40	5	60	26,80 €	76 / 40		13,90 €
89	89 / 40	4	48	30,95 €	89 / 40	14,1	14,35 €
108	108 / 40	1	33	36,65 €	108 / 40	20	16,50 €

Vonk. Ø potr. (mm):	TECLIT PS Cold				Iz. záves TECLIT HA		
	Obj, kód	bm/ bal.	bm/ pal.	EUR/bm bez DPH	Obj, kód	ks/ bal.	EUR/ks bez DPH
Hr. izolácie 50 mm							
89	89 / 50	1	33	40,20 €	89 / 50	20	17,15 €
108	108 / 50	1	27	44,75 €	108 / 50	12	18,55 €
114	114 / 50	1	25	46,35 €	114 / 50	8	22,85 €
133	133 / 50	1	24	50,30 €			
140	140 / 50	1	20	52,60 €	140 / 50	6	30,55 €
159	159 / 50	1	16	58,25 €	159 / 50	6	37,80 €
168	168 / 50	1	16	60,00 €	168 / 50	6	44,95 €
219	219 / 50	1	16	78,10 €	219 / 50	80	81,90 €
Hr. izolácie 60 mm							
60	60 / 60	4	48	40,60 €	60 / 60	20	15,90 €
64	64 / 60	1	36	41,25 €	64 / 60	20	15,95 €
Hr. izolácie 70 mm							
76	76 / 70	1	25	58,15 €	76 / 70	13	21,10 €
Hr. izolácie 80 mm							
76	76 / 80	1	20	61,85 €	76 / 80	10	22,80 €
89	89 / 80	1	19	71,65 €	-	-	
Hr. izolácie 100 mm							
108	108 / 100	1	11	100,35 €	108 / 100	5	55,15 €
114	114 / 100	1	11	102,40 €	114 / 100	5	56,40 €
133	133 / 100	1	10	110,35 €			
140	140 / 100	1	9	115,55 €	140 / 100	88	60,75 €
159	159 / 100	1	8	126,30 €	159 / 100	88	62,20 €
168	168 / 100	1	8	128,25 €	168 / 100	88	67,25 €
219	219 / 100	1	6	154,00 €	219 / 100	55	75,15 €

Príslušenstvo k systémom TECLIT:

Obj, kód	ks/ bal.	EUR/ks bez DPH
Páska ALU TECLIT AT 50 (50mm x 50m x 0,03mm)	24	31,60 €
Páska ALU TECLIT AT 100 (100mm x 50m x 0,03mm)	12	44,05 €
Páska tesniaca ALU TECLIT FT 50 (50mm x 20m x 1,1mm)	1	162,00 €
Páska tesniaca ALU TECLIT FT 150 (150mm x 20m x 1,1mm)	1	394,20 €



LAMELOVÉ PÁSY s ALS fóliou

Rockwool TECLIT LM			
hr. (mm)	EUR/m2 bez DPH	m2/ bal.	m2/ pal.
25	16,95 €	12	120
30	18,95 €	8	96
40	23,55 €	6	72
50	28,05 €	5	60

Technológia WR-Tech chráni technologické zariadenia pred vodou



Viac na rti.rockwool.com

 **ROCKWOOL®**



Ochrana proti korózií pod izoláciou

Izolácia z kamennej vlny ProRox s technológiou WR-Tech Water Repellency Technology bola prvá svojho druhu. Je najlepším riešením vo svojej triede, znižuje riziko vzniku korózie pod izoláciou a udržuje Vašu fabriku v suchu.

Teraz v rohožiach ProRox WM na drôtenom pletive.

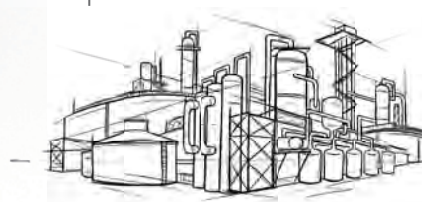

TECHNICAL INSULATION

SKRUŽE bez AL fólie



ROCKWOOL ProRox PS 960 je potrubná izolácia vyrábaná navíjaním na tvarovacie jadro.

Izolačné puzdra sa vyrábajú z kamennej vlny a za pomoci inovatívneho spojiva odpudzujúceho vodu WR-Tech kvôli znižovaniu rizika korózie pod izoláciou. Na požiadanie je k dispozícii obloženie z vystuženej hliníkovej fólie.

Dĺžka 1m. Max. prevádzková teplota 650°C. Objemová hmotnosť 100kg/m³.

Súčiniteľ tepelnej vodivosti λ50°C = 0,040 W/m.K. Trieda reakcie na oheň A1.



PROROX

Vonk. Ø potr. (mm):	ProRox PS 960				ProRox PS 960				ProRox PS 960				ProRox PS 960			
	Hr. izolácie 25 mm				Hr. izolácie 30 mm				Hr. izolácie 40 mm				Hr. izolácie 50 mm			
	Obj, kód	bm/ bal.	bm/ pal.	EUR/bm bez DPH	Obj, kód	bm/ bal.	bm/ pal.	EUR/bm bez DPH	Obj, kód	bm/ bal.	bm/ pal.	EUR/bm bez DPH	Obj, kód	bm/ bal.	bm/ pal.	EUR/bm bez DPH
28	28 / 25	25	300	5,25 €	28 / 30	16	192	7,00 €	28 / 40	12	144	9,75 €	28 / 50	9	108	12,65 €
35	35 / 25	20	240	6,15 €	35 / 30	16	192	7,95 €	35 / 40	9	108	10,70 €	35 / 50	7	84	13,75 €
42	42 / 25	16	192	7,00 €	42 / 30	12	144	8,90 €	42 / 40	9	108	11,70 €	42 / 50	6	72	14,90 €
48	48 / 25	15	180	7,70 €	48 / 30	12	144	9,75 €	48 / 40	9	108	12,45 €	48 / 50	6	72	15,90 €
54	54 / 25	12	144	8,40 €	54 / 30	10	120	10,55 €	54 / 40	8	96	13,30 €	54 / 50	5	60	16,85 €
60	60 / 25	11	132	9,20 €	60 / 30	9	108	11,35 €	60 / 40	6	72	14,10 €	60 / 50	5	60	17,90 €
64	64 / 25	9	108	9,70 €	64 / 30	9	108	11,90 €	64 / 40	6	72	14,65 €	64 / 50	4	48	18,50 €
70	70 / 25	9	108	10,40 €	70 / 30	8	96	12,75 €	70 / 40	5	60	15,40 €	70 / 50	4	48	19,55 €
76	76 / 25	9	108	11,15 €	76 / 30	7	84	13,60 €	76 / 40	5	60	16,25 €	76 / 50	4	48	20,55 €
89	89 / 25	6	72	12,80 €	89 / 30	6	72	15,35 €	89 / 40	4	48	18,00 €	89 / 50	1	33	22,65 €
102	102 / 25	5	60	14,40 €	102 / 30	4	48	17,15 €	102 / 40	1	36	19,75 €	102 / 50	1	28	24,75 €
108	108 / 25	5	60	15,10 €	108 / 30	4	48	18,00 €	108 / 40	1	33	20,55 €	108 / 50	1	25	25,80 €
114	114 / 25	4	48	15,80 €	114 / 30	4	48	18,85 €	114 / 40	1	32	21,35 €	114 / 50	1	25	26,80 €
121	121 / 25	4		16,70 €	121 / 30	4	36	19,80 €	121 / 40	1	30	22,30 €	121 / 50	1	24	27,95 €
127	127 / 25	4	48	17,50 €	127 / 30	1	33	20,60 €	127 / 40	1	27	23,15 €	127 / 50	1	23	28,95 €
133	133 / 25	1	36	17,70 €	133 / 30	1	32	21,45 €	133 / 40	1	25	23,90 €	133 / 50	1	24	29,90 €
140	140 / 25	1	33	19,10 €	140 / 30	1	30	22,40 €	140 / 40	1	24	24,80 €	140 / 50	1	20	31,10 €
159	159 / 25		27	21,45 €	159 / 30	1	25	25,00 €	159 / 40	1	20	27,40 €	159 / 50	1	16	34,20 €
169	169 / 25		25	22,65 €	169 / 30		22	26,40 €	169 / 40	1	19	28,75 €	169 / 50	1	16	35,90 €
194	194 / 25	1	19	25,75 €	194 / 30	1	17	29,85 €	194 / 40	1	14	32,10 €	194 / 50	1	12	40,00 €
219	219 / 25	1	16	28,85 €	219 / 30	1	14	33,25 €	219 / 40	1	12	35,45 €	219 / 50	1	11	44,10 €
245	245 / 25	1		32,05 €	245 / 30	1		36,85 €	245 / 40	1	11	38,95 €	245 / 50	1	9	48,35 €
273	273 / 25	1		35,50 €	273 / 30	1	10	40,70 €	273 / 40	1	9	42,70 €	273 / 50	1	8	53,00 €
305	305 / 25	1			305 / 30	1	8	45,10 €	305 / 40	1	6	47,05 €	305 / 50	1	6	58,25 €
324	324 / 25	1		41,85 €	324 / 30		6	47,70 €	324 / 40		6	49,55 €	324 / 50	1	5	61,40 €
356					356 / 30	1	6	52,15 €	356 / 40	1	6	53,90 €	356 / 50	1	5	66,70 €
406					406 / 30			58,50 €	406 / 40	1	4	60,65 €	406 / 50	1	4	74,95 €
456					456 / 30	14,1		64,90 €	456 / 40	1		67,30 €	456 / 50	1		83,15 €
508									508 / 40	1		75,00 €	508 / 50	1		91,75 €
558													558 / 50	1		100,00 €
610													610 / 50	1		108,55 €
660													660 / 50	1		116,80 €
712													712 / 50	1		125,40 €
813													813 / 50	1		142,00 €
915													915 / 50	1		158,85 €



Vonk. Ø potr. (mm):	ProRox PS 960				ProRox PS 960				ProRox PS 960				ProRox PS 960			
	Hr. izolácie 60 mm				Hr. izolácie 80 mm				Hr. izolácie 100 mm				Hr. izolácie 120 mm			
	Obj. kód	bm/ bal.	bm/ pal.	EUR/bm bez DPH	Obj. kód	bm/ bal.	bm/ pal.	EUR/bm bez DPH	Obj. kód	bm/ bal.	bm/ pal.	EUR/bm bez DPH	Obj. kód	bm/ bal.	bm/ pal.	EUR/bm bez DPH
28	28 / 60	6	72	19,55 €	28 / 80	1	33	33,40 €								
35	35 / 60	5	60	20,85 €	35 / 80	1	30	35,05 €								
42	42 / 60	4	48	22,20 €	42 / 80	1	28	36,60 €								
48	48 / 60	4	48	23,35 €	48 / 80	1	27	38,00 €								
54	54 / 60	4	48	24,45 €	54 / 80			38,75 €								
60	60 / 60	4	48	25,50 €	60 / 80	1	24	40,80 €	60 / 100	1	16	51,95 €	60 / 120	1		62,40 €
64	64 / 60	1	36	26,30 €	64 / 80	1	24	41,70 €	64 / 100	1		53,15 €	64 / 120			63,95 €
70	70 / 60	1	33	27,40 €	70 / 80	1	24	43,05 €	70 / 100	1		54,95 €	70 / 120			66,50 €
76	76 / 60	1	30	28,50 €	76 / 80	1	20	44,45 €	76 / 100	1	14	56,75 €	76 / 120	1		67,65 €
89	89 / 60	1	27	30,95 €	89 / 80	1	19	47,40 €	89 / 100	1	12	60,60 €	89 / 120	1	10	71,90 €
102	102 / 60	1	24	33,40 €	102 / 80	1	16	50,45 €	102 / 100	1	12	64,40 €	102 / 120			75,95 €
108	108 / 60	1	23	34,50 €	108 / 80	1	16	51,80 €	108 / 100	1	11	66,20 €	108 / 120			78,35 €
114	114 / 60	1	20	35,65 €	114 / 80	1	15	53,15 €	114 / 100	1	11	67,95 €	114 / 120	1	8	80,10 €
121	121 / 60	1	20	36,95 €	121 / 80	1	14	54,85 €	121 / 100	1	11	70,00 €	121 / 120			82,25 €
127	127 / 60	1	19	38,05 €	127 / 80	1	12	56,20 €	127 / 100	1	10	71,80 €	127 / 120			
133	133 / 60	1	17	39,15 €	133 / 80	1	12	57,55 €	133 / 100	1	10	73,55 €	133 / 120	1		
140	140 / 60	1	16	40,50 €	140 / 80	1	12	59,20 €	140 / 100	1	9	75,65 €	140 / 120	1	8	88,65 €
159	159 / 60	1	14	44,05 €	159 / 80	1	11	63,55 €	159 / 100	1	8	81,30 €	159 / 120	1		94,85 €
169	169 / 60	1	12	45,90 €	169 / 80	1	10	65,85 €	169 / 100	1	8	84,25 €	169 / 120	1	6	98,10 €
194	194 / 60	1	11	50,55 €	194 / 80	1	8	71,60 €	194 / 100	1	6	91,65 €	194 / 120	1		
219	219 / 60	1	9	55,25 €	219 / 80	1	8	77,30 €	219 / 100	1	6	99,00 €	219 / 120	1	5	114,55 €
245	245 / 60	1	8	60,05 €	245 / 80	1	6	83,40 €	245 / 100	1	5	106,75 €	245 / 120	1		123,05 €
273	273 / 60	1	6	65,35 €	273 / 80	1	5	89,75 €	273 / 100	1	5	115,05 €	273 / 120	1	4	132,20 €
305	305 / 60	1	5	71,30 €	305 / 80	1	5	97,15 €	305 / 100	1	4	124,50 €	305 / 120	1		
324	324 / 60	1	5	74,80 €	324 / 80	1	4	101,55 €	324 / 100	1		130,05 €	324 / 120	1		149,00 €
356	356 / 60	1	4	80,80 €	356 / 80	1	4	108,90 €	356 / 100	1		139,55 €	356 / 120	1		159,45 €
406	406 / 60	1		90,15 €	406 / 80	1		120,35 €	406 / 100	1		154,35 €	406 / 120	1		175,85 €
456	456 / 60	1		99,45 €	456 / 80	1		131,90 €	456 / 100	1		169,10 €	456 / 120			189,45 €
508	508 / 60	1		109,20 €	508 / 80	1		143,80 €	508 / 100	1		184,50 €	508 / 120			212,15 €
558	558 / 60	1		118,50 €	558 / 80	1		155,35 €	558 / 100	1		199,30 €	558 / 120			229,15 €
610	610 / 60	1		128,25 €	610 / 80	1		167,30 €	610 / 100	1		214,70 €	610 / 120			240,45 €
660	660 / 60	1		137,55 €	660 / 80	1		178,85 €	660 / 100	1		229,45 €	660 / 120			257,00 €
712	712 / 60	1		147,25 €	712 / 80	1		190,80 €	712 / 100	1		244,85 €				
813	813 / 60	1		166,10 €	813 / 80	1		214,05 €	813 / 100	1		274,75 €				

LAMELOVÉ PÁSY s ALS fóliou

Lamelový izolačný pás z čadičovej vlny nalepený na hliníkovú fóliu vystuženú sklotextilnou mriežkou.

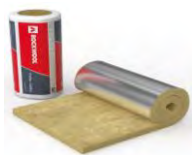

ProRox LM 930 ALU (Larock 55 ALS)			
hr. (mm)	EUR/m2 bez DPH	m ² / bal.	m ² / pal.
30	12,70 €	8	192
40	15,80 €	6	144
50	19,70 €	4	96
60	22,45 €	3	72
80	28,55 €	2,5	60
100	33,90 €	2	48

Max.550°C. Šírka 1m.

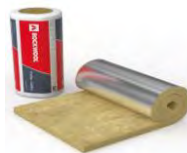

ProRox MA 520 ALU (60kg/m3)			
hr. (mm)	EUR/m2 bez DPH	m ² / bal.	m ² / pal.
50	34,95 €	5	-
60	38,60 €	4,5	-
80	44,40 €	3,5	-
100	51,05 €	3	-

Max.500°C. Šírka 0,5m.

ROHOŽE na drôtenom pletive "WM"

Izolačné rohože z kamennej vlny spájané organickou živicom s jednostranne našitým drôteným pozinkovaným pletivom.



ProRox WM 920 (WM 60)			
hr. (mm)	EUR/m2 bez DPH	m ² / bal.	m ² / pal.
50	19,25 €	4,5	94,5
60	22,65 €	4	84
80	28,05 €	3,5	73,5
100	35,10 €	2,5	52,5

Max.500°C. Šírka 0,5m.



ProRox WM 950 (WM 80)			
hr. (mm)	EUR/m2 bez DPH	m ² / bal.	m ² / pal.
40	19,60 €	5,5	115,5
50	22,35 €	4	84
60	25,30 €	3,5	73,5
80	31,10 €	3	63
100	37,00 €	2,5	52,5

Max.640°C. Šírka 1m (na obj. 0,5m).

ProRox WM 960 (WM 100)			
hr. (mm)	EUR/m2 bez DPH	m ² / bal.	m ² / pal.
30	17,20 €	6	126
40	21,55 €	5	105
50	26,00 €	4	84
60	30,55 €	3	63
70	35,35 €	2,5	52,5
80	40,15 €	2,5	52,5
90	44,95 €	2	42
100	49,75 €	2	42

Max.660°C. Šírka 1m.

ProRox WM 970			
hr. (mm)	EUR/m2 bez DPH	m ² / bal.	m ² / pal.
50	31,70 €	4	60
60	37,25 €	3	45
80	48,95 €	2,5	37,5
100	60,70 €	2	30

Max.500°C. Šírka 0,5m.

Voľná vlna



ProRox LF 970D			
hr. (mm)	EUR/kg bez DPH	kg/ bal.	kg/ pal.
-	5,15 €	15	420

Šírka 1m



ProRox GR 903			
hr. (mm)	EUR/kg bez DPH	kg/ bal.	kg/ pal.
-	5,05 €	15	240

DOSKY

Izolačné dosky z kamennej vlny sú určené pre tepelnú a akustickú izoláciu technických zariadení, ako sú nádrže, pece, kotle, kolóny, dymovody, elektrostatické odlučovače a pod.



ProRox SL 920 (Techrock 40)				ProRox SL 930 (Techrock 60)				ProRox SL 950 (Techrock 80)			
hr. (mm)	EUR/m2 bez DPH	m ² / bal.	m ² / pal.	hr. (mm)	EUR/m2 bez DPH	m ² / bal.	m ² / pal.	hr. (mm)	EUR/m2 bez DPH	m ² / bal.	m ² / pal.
40	8,75 €	7,2	180	40	14,10 €	7,2	72	40	16,60 €	7,2	72
50	11,00 €	4,8	144	50	16,50 €	6	60	50	20,95 €	6	60
60	13,10 €	4,8	120	60	19,80 €	4,8	48	60	25,15 €	4,8	48
80	17,45 €	3,6	90	80	26,45 €	3,6	36	80	33,15 €	3,6	36
100	21,85 €	2,4	72	100	32,10 €	3	30	100	41,50 €	3	30

Max.400°C. Rozmery 0,6 x 1m.

Max.560°C. Rozmery 0,6 x 1m.

Max.640°C. Rozmery 0,6 x 1m.

ProRox SL 960 (Techrock 100)				ProRox SL 970 (Techrock 120)				ProRox SL 586 (Techrock 150)			
hr. (mm)	EUR/m2 bez DPH	m ² / bal.	m ² / pal.	hr. (mm)	EUR/m2 bez DPH	m ² / bal.	m ² / pal.	hr. (mm)	EUR/m2 bez DPH	m ² / bal.	m ² / pal.
40	20,45 €	6	72					40	22,10 €	4,2	75,6
50	24,05 €	4,8	57,6	50	27,25 €	3,6	57,6	50	27,50 €	2,4	62,4
60	28,85 €	3,6	50,4					60	33,00 €	2,4	48
80	39,55 €	3	36								
100	48,05 €	2,4	28,8	100	54,35 €	1,8	28,8	100	55,00 €	1,2	31,2

Max.660°C. Rozmery 0,6 x 1m.

Max.680°C. Rozmery 0,6 x 1m.

Max.700°C. Rozmery 0,6 x 1m.

Požiarная ochrana inštalácií TZB

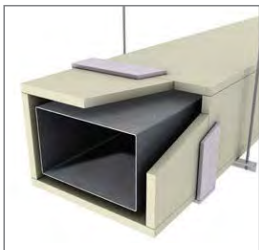

VZT potrubia s požiarную odolnosťou



Potrubia na odvod dymu



Káblové kanály s funkčnou odolnosťou pri požari

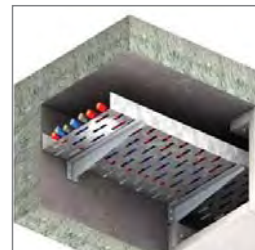

Inštaláčne kanály

Požiarne tesnenie prestupov a lineárnych stykov

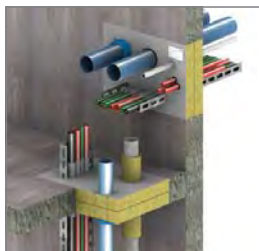

Tesnenie prestupov káblov



Tesnenie prestupov plastových rúr



Tesnenie prestupov kovových rúr

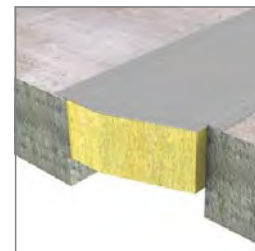

Tesnenie lineárnych stykov



DOSKY PROMATECT®

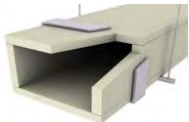

Protipožiarne kalkciúmsilikátová doska, odolná proti vlhkosti, stabilná a samonosná. Zhotovenie požiarnej konštrukcie podľa požiadaviek EN pre všetky oblasti stavebníctva, napríklad požiarne chránené plechové VZT potrubie, samonosné VZT potrubie s požiarou odolnosťou, potrubie na odvod tepla a spodín horenia.

Promat

PROMATECT® AD

hr. (mm)	EUR/m ² bez DPH	m ² /ks	EUR/ks bez DPH	ks/pal.
40	112,40 €	3,0	337,20 €	20

Rozmery 1,2 x 2,5m - 500kg/m³

PROMATECT® L500

hr. (mm)	EUR/m ² bez DPH	m ² /ks	EUR/ks bez DPH	ks/pal.
25	97,70 €	3,0	293,10 €	35
50	195,20 €	3,0	585,60 €	16

Rozmery 1,2 x 2,5m - 500kg/m³

PROMATECT® H

hr. (mm)	EUR/m ² bez DPH	m ² /ks	EUR/ks bez DPH	ks/pal.
10	70,50 €	3,125	220,31 €	40
12	84,50 €	3,125	264,06 €	30
25	173,50 €	3,125	542,19 €	15

Rozmery 1,25 x 2,5m - 870kg/m³

Príslušenstvo:



Promat-K84 grey	Anorganické lepidlo na vzduchotechnické potrubia PROMATECT® a potrubia pre odvod tepla a spodín horenia, pre lepenie protipožiarnej dosky Promat a minerálnej vlny v špeciálnych požiarnej konštrukciách, pre použitie v požiarnej uzáveroch, vo všetkých interiérových aplikáciách okrem použitia vo vlhkom prostredí.	kg / ks	EUR/kg bez DPH	EUR/ks bez DPH
		15	11,14 €	167,10 €
		1	12,80 €	12,80 €

Požiarne tesnenie prestupov - PROMAT

Tesnenia prestupov inštalácií cez požiarne steny a stropy.



PROMASEAL®-A	Protipožiarne jednozložkové tmel na akrylátovej báze. Vďaka jeho vynikajúcim aplikačným vlastnostiam sa dajú škáry a otvory utesniť veľmi rýchlo a bezpečne. Tmel sa používa na tesnenie škár v stenách a stropoch s pohybom najviac 7,5%. Môže sa používať ako tesnenie medzi konštrukčnými prvkami stavby a izoláciou.	l / ks	EUR/l bez DPH	EUR/ks bez DPH
		0,310	34,19 €	10,60 €
PROMASEAL®-AG	Protipožiarne intumescentný tmel určený pre tesnenie otvorov v požiarnej stenách a stropoch. Je vhodný pre použitie na tesnenie prestupov káblov, káblových zväzkov, káblových prechodiek, horľavých rúr ako aj horľavých rúr s horľavými izoláciami, ako ochrana proti prestupu ohňa, dymu a tepla.	l / ks	EUR/l bez DPH	EUR/ks bez DPH
		0,310	75,16 €	23,30 €
PROMASTOP®-CC	Protipožiarne náter na vodnej báze určený pre tesnenie otvorov v požiarnej stenách a stropoch. Je vhodný pre použitie na tesnenie prestupov káblov, káblových zväzkov, horľavých a nehorľavých rúr, ako aj pre VZT potrubia s požiarou odolnosťou a na tesnenie lineárnych stykov konštrukcií.	kg / ks	EUR/kg bez DPH	EUR/ks bez DPH
		12,5	28,04 €	350,50 €
PROMASTOP®-W	Expandujúci protipožiarne návin, umožňuje zhotoviť ovinutie ľubovoľného Ø priamo na mieste. Je testovaný pre maltové systémy a mäkké upchávkové prestupov cez steny/stropy pre použitie so všetkými bežnými plastovými potrubiami, PVC, PE, PVC, viacvrstvové nízkoohľadné kanalizačné rúry, ako aj izol. AL kompozitné a kovové rúry.	m / ks	EUR/m bez DPH	EUR/ks bez DPH
		18	18,56 €	334,00 €

PROMATECT® - systém protipožiarnej ochrany VZT EI 30, 45, 60, 90, 120 min.

Potrubie max. rozmerov 1,25 x 1m	Potrubie	EI 30	EI 45	EI 60	EI 90	EI 120
Požiar z vonka	↑	25 mm	25 mm	25 mm	25 mm	25 mm
Požiar z vonka	↔	25 mm	25 mm	25 mm	40 mm	40 mm
Požiar z vnútra	↓	25 mm	30 mm	30 mm	50 mm	50 mm
Požiar z vnútra	↔	25 mm	30 mm	30 mm	40 mm	50 mm

Potrubie max. rozmerov 2,3 x 0,85m	Potrubie	EI 30	EI 45	EI 60	EI 90	EI 120
Požiar z vonka	↔	30 mm	30 mm	30 mm	30 mm	50 mm
Požiar z vnútra	↔	30 mm	30 mm	50 mm	50 mm	50 mm

PROMATECT®- systém pre odvod dymu a tepla EI 30, 60, 120 min.

Odvod dymu a tepla	Potrubie	EI 30 S 1000 multi	EI 60 S 1500 multi	EI 120 S 1500 multi
Potrubie max. rozmer 1,25 x 1m	↔ ↓	25 mm	30 mm	-
Potrubie max. rozmer 1,25 x 1m	↔	-	-	50mm
Potrubie max. rozmer 2,3 x 0,85m	↔	-	30mm	-
Potrubie max. rozmer 2,3 x 0,85m	↔	-	-	50mm

ROHOŽE žiaruvzdorné



Izolačná rohož je vyrobená z keramického vlákna, ktoré je netkanou technológiou formované do pevnej, ľahkej a odolnej rohože pre vysoké teploty.

1260°C (96kg/m ³)				1260°C (128kg/m ³)				* Orientačné rozmery (mm)
hr. (mm)	EUR/m ² bez DPH	EUR/bal. bez DPH	*m ² /bal.	hr. (mm)	EUR/m ² bez DPH	EUR/bal. bez DPH	*m ² /bal.	
13	7,28 €	65,00 €	8,93	13	8,51 €	76,00 €	8,93	610 x 14 640
19	10,92 €	65,00 €	5,95	19	12,77 €	76,00 €	5,95	610 x 9 760
25	14,56 €	65,00 €	4,47	25	17,02 €	76,00 €	4,47	610 x 7 320
38	21,84 €	65,00 €	2,98	38	25,53 €	76,00 €	2,98	610 x 4 880
50	29,11 €	65,00 €	2,23	50	34,04 €	76,00 €	2,23	610 x 3 660

* V závislosti od dostupnosti, môžu byť rohože dodané v inom rozmere.

PAPIER žiaruvzdorný 1260°C



Papier 1260°C				
Hr. (mm)	EUR/m ² bez DPH	EUR/bal. bez DPH	*m ² /ks.	* Orientačné rozmery (mm)
1	cena na vyžiadanie		48,8	1 220 x 40 000
2	cena na vyžiadanie		24,4	1 220 x 20 000
3	cena na vyžiadanie		18,3	1 220 x 15 000
4	cena na vyžiadanie		12,2	1 220 x 10 000
5	cena na vyžiadanie		12,2	1 220 x 10 000

* V závislosti od dostupnosti, môže byť papier dodaný v inom rozmere.

DOSKY žiaruvzdorné 1260°C



Dosky sú vyrobené z keramických vlákien, organických a anorganických pojív. Izolačné dosky sú vákuovo tvarované výrobky, odolávajú vyšším rýchlostiam spalín v peciach.

Dosky 1260°C				
Hr. (mm)	EUR/m ² bez DPH	EUR/ks bez DPH	*m ² /ks.	* Orientačné rozmery (mm)
10	cena na vyžiadanie		1,25	1 250 x 1 000
13	cena na vyžiadanie		1,25	1 250 x 1 000
15	cena na vyžiadanie		1,25	1 250 x 1 000
19	cena na vyžiadanie		1,25	1 250 x 1 000
25	cena na vyžiadanie		1,25	1 250 x 1 000
50	cena na vyžiadanie		1,25	1 250 x 1 000

* V závislosti od dostupnosti, môžu byť dosky dodané v inom rozmere.

TEMKET snímateľné púzdra



Snímateľné púzdra TEMKET sú určené k eliminácii tepelných strát armatúr, filtrov, šupátok, ventilov, potrubia, kolien a veľa ďalších zariadení. Používajú sa namiesto klasických plechových "snímačiek", a to predovšetkým k výhode rýchleho zloženia a opätovného nasadenia - použitia. Vhodné a ideálne použitie pre kotolne, výmenníkové stanice, v teplárenskom a energetickom priemysle atď.
 Izolácia slúži ako ochrana pracovníkov pred popálením, sú umývateľné a ich povrch je možné čistiť.

Zloženie puzdier

Produkt TEMKET je vyrobený zo sklotextílie Temtex s polyuretánovým záterom. Pásy so suchým zipsom slúžia k dokonalému stiahnutiu izolácie a šnúrky na konci stiahnu púzdro k povrchu podkladu.

	Typ armatúry: Ø (mm)	TEMKET UV	TEMKET RV	TEMKET eIV	TEMKET mix	TEMKET UK	TEMKET ZK	TEMKET F	TEMKET ZV	TEMKET KK	TEMKET PR
		Uzatvárací ventil	Regulačný ventil	Elektroventil	Trojcestný ventil	Uzatváracia klapka	Spätná klapka	Filter	Spätný ventil	Guľový ventil	Prírubový spoj
		EUR/ks bez DPH	EUR/ks bez DPH	EUR/ks bez DPH	EUR/ks bez DPH	EUR/ks bez DPH	EUR/ks bez DPH	EUR/ks bez DPH	EUR/ks bez DPH	EUR/ks bez DPH	EUR/ks bez DPH
TEMKET a - púzdra do 150°C (hr. izolácie 40mm)	DN15	52 €	71 €	70 €	106 €	51 €	54 €	56 €	56 €	51 €	50 €
	DN20	55 €	74 €	72 €	109 €	52 €	58 €	60 €	60 €	52 €	52 €
	DN25	55 €	75 €	74 €	110 €	52 €	58 €	62 €	62 €	52 €	52 €
	DN32	58 €	78 €	76 €	114 €	54 €	59 €	66 €	64 €	55 €	54 €
	DN40	59 €	80 €	79 €	118 €	55 €	62 €	70 €	70 €	56 €	56 €
	DN50	62 €	84 €	83 €	125 €	56 €	63 €	75 €	75 €	59 €	58 €
	DN65	68 €	91 €	90 €	135 €	59 €	66 €	90 €	88 €	64 €	60 €
	DN80	71 €	96 €	95 €	142 €	60 €	67 €	95 €	94 €	68 €	62 €
	DN100	78 €	106 €	103 €	155 €	62 €	70 €	102 €	102 €	74 €	63 €
	DN125	90 €	121 €	118 €	178 €	66 €	74 €	121 €	121 €	84 €	67 €
	DN150	111 €	150 €	149 €	222 €	68 €	78 €	146 €	145 €	106 €	71 €
DN200	137 €	185 €	182 €	273 €	74 €	84 €	169 €	168 €	130 €	76 €	
DN250	153 €	208 €	204 €	306 €	82 €	94 €	189 €	188 €	146 €	86 €	
TEMKET b - púzdra do 210°C (hr. izolácie 50mm)	DN15	76 €	92 €	91 €	137 €	68 €	83 €	74 €	74 €	72 €	75 €
	DN20	82 €	96 €	98 €	146 €	71 €	86 €	79 €	79 €	78 €	78 €
	DN25	86 €	103 €	102 €	153 €	71 €	87 €	83 €	82 €	82 €	79 €
	DN32	92 €	110 €	110 €	165 €	72 €	90 €	90 €	88 €	87 €	82 €
	DN40	103 €	122 €	123 €	184 €	75 €	92 €	98 €	96 €	98 €	84 €
	DN50	110 €	131 €	130 €	196 €	76 €	95 €	107 €	107 €	105 €	87 €
	DN65	122 €	158 €	145 €	217 €	80 €	99 €	135 €	135 €	115 €	90 €
	DN80	127 €	163 €	153 €	229 €	82 €	102 €	139 €	138 €	122 €	92 €
	DN100	146 €	182 €	174 €	261 €	84 €	106 €	155 €	154 €	138 €	96 €
	DN125	169 €	212 €	202 €	303 €	87 €	111 €	189 €	188 €	161 €	101 €
	DN150	216 €	251 €	257 €	387 €	92 €	118 €	235 €	232 €	205 €	107 €
DN200	268 €	319 €	319 €	478 €	99 €	127 €	275 €	272 €	255 €	115 €	
DN250	300 €	356 €	356 €	536 €	111 €	142 €	307 €	306 €	284 €	130 €	
TEMKET c - púzdra do 280°C (hr. izolácie 60mm)	DN15	87 €	106 €	113 €	168 €	86 €	103 €	84 €	83 €	83 €	94 €
	DN20	94 €	110 €	119 €	180 €	88 €	107 €	91 €	90 €	88 €	98 €
	DN25	98 €	118 €	126 €	189 €	88 €	109 €	95 €	94 €	92 €	98 €
	DN32	106 €	126 €	135 €	204 €	91 €	111 €	102 €	102 €	101 €	102 €
	DN40	118 €	139 €	151 €	226 €	94 €	115 €	111 €	111 €	111 €	106 €
	DN50	126 €	150 €	161 €	241 €	96 €	119 €	123 €	122 €	119 €	109 €
	DN65	139 €	181 €	178 €	267 €	99 €	123 €	155 €	154 €	131 €	113 €
	DN80	146 €	186 €	188 €	281 €	102 €	127 €	159 €	158 €	139 €	115 €
	DN100	168 €	208 €	214 €	322 €	105 €	131 €	178 €	177 €	158 €	119 €
	DN125	194 €	243 €	249 €	373 €	110 €	138 €	217 €	216 €	184 €	126 €
	DN150	248 €	287 €	318 €	477 €	115 €	146 €	268 €	265 €	235 €	133 €
DN200	307 €	364 €	393 €	590 €	123 €	159 €	314 €	312 €	291 €	145 €	
DN250	343 €	407 €	440 €	659 €	138 €	178 €	351 €	348 €	326 €	161 €	

PÁSY ArmaGEL HT



tepelnoizolačné vlastnosti dovoľujú použiť menšiu hrúbku izolácie. Izolácia ArmaGel HT má vode odpudivé vlastnosti, znižuje riziko vzniku korózie pod izoláciou. Maximálna teplota použitia +650°C. Súčiniteľ tepelnej vodivosti $\lambda_{38^\circ\text{C}} = 0,022\text{W/m.K}$.

Armagel HT						
Hr. izol. (mm)	Rola (šírka 1,5m) Obj. kód	m ² /bal.	EUR/m ² bez DPH	Rola (šírka 1m) Obj. kód	m ² /bal.	EUR/m ² bez DPH
5	AGH-05-00/150S	24	87,50 €	AGH-05-00/150P	97,5	87,50 €
10	AGH-10-00/150S	12	116,70 €	AGH-10-00/150P	60	116,70 €
15	AGH-15-00/150S	9	173,30 €	AGH-15-00/150P	39	173,30 €
20	AGH-20-00/150S	6	236,30 €	AGH-20-00/150P	30	236,30 €

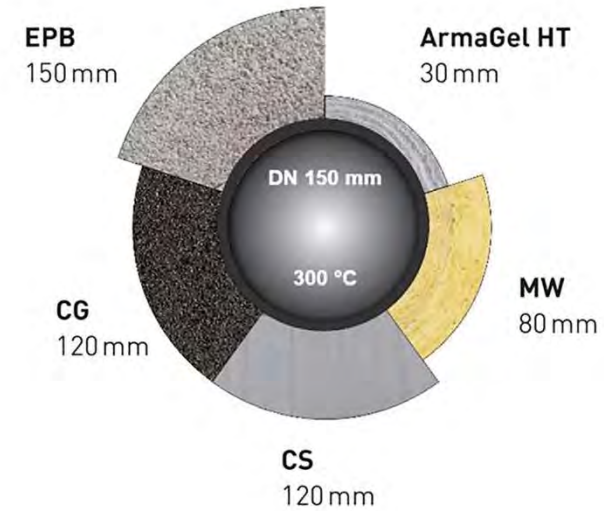



EKAFOL
EKAMAT

 **SEBALD**
ISO-SYSTEME



EKATEC
EKAMET



EKAFOL Isogenopak® - biela, šedá PVC fólia (Okapak, Durofol)

Tvarovky z PVC fólie bielej farby: Kolená 90°, 45°, T kusy, fólia v roli, čelíčka

Tvarovky z PVC fólie šedej farby: Kolená 90°, 45°, T kusy, fólia v roli, čelíčka, púzdra na armatúry)

PVC fólia v roli (Plastic foil in rolls)

Isogenopak® 350 SE

farba	Šírka:	Bal.:	EUR/m2 bez DPH
biela	1,2m	30 m2	7,00 €
šedá	1 m	35 m2	7,00 €



45° kolená (45° Bends)

Vonk. Ø na izolácii (mm):	Koleno z jedného kusa	Koleno zlepené z dvoch častí
52	3,51 €	
58	4,07 €	3,55 €
62	4,11 €	3,58 €
68		3,58 €
72	4,73 €	
75		4,73 €
78		4,73 €
82	5,60 €	
85		5,35 €
88		5,40 €
92	6,34 €	6,13 €
95		6,44 €
98		6,47 €
102	6,53 €	7,04 €
110		8,41 €
115	8,93 €	8,85 €
120		9,96 €
128	10,58 €	10,52 €
136		11,27 €
141	13,68 €	13,57 €
149		13,89 €
154	19,21 €	19,12 €
160		20,74 €
167	21,50 €	21,35 €
176	21,50 €	21,35 €
189		26,09 €
193	24,93 €	
206	26,65 €	
219	28,70 €	
232	36,28 €	
245	37,94 €	
271	46,87 €	

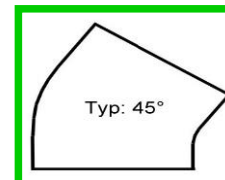

EUR/ks
bez
DPH

T Kus 45° (Tees diagonal 45°)

Vonk. Ø na izolácii (mm):	Priemer pripojky (mm):	EUR/ks bez DPH
96	80	26,45 €
96	90	31,51 €
100	100	35,36 €
103	90	35,36 €
115	90	35,36 €
110	100	35,36 €
116	110	35,36 €
123	110	35,36 €
130	90	38,10 €
136	110	38,10 €
136	136	38,10 €
150	110	54,75 €
156	156	54,75 €
160	160	54,75 €
176	136	71,88 €
176	176	71,88 €
190	180	85,88 €
196	196	95,43 €
203	190	95,43 €
219	190	109,58 €
230	190	128,43 €
236	236	128,43 €
240	240	129,11 €
276	216	129,83 €
276	276	130,10 €

T-Kus 90° (Tees multi fit junction)

Vonk. Ø na izolácii (mm):	Priemer odbočky (mm):	EUR/ks bez DPH
61	61-57	5,88 €
67	67-57	5,92 €
73	73-57	5,97 €
82	82-57	6,73 €
88	88-52	7,19 €
93	93-57	8,22 €
102	102-57	9,10 €
120	120-67	10,66 €
120	120-98	10,66 €
160	160-93	26,40 €

Čelíčka (End caps)

Vonk. Ø na izolácii (mm):	EUR/ks bez DPH
60-70	5,92 €
70-80	6,34 €
80-90	6,60 €
90-100	6,79 €
100-110	7,01 €
110-130	7,87 €
130-150	8,74 €
150-170	9,60 €
170-190	11,45 €
190-210	12,56 €
210-250	14,22 €
250-290	15,73 €
290-330	17,47 €
330-360	41,64 €
360-400	51,55 €
400-440	56,71 €
440-480	61,20 €
480-530	73,33 €
530-580	88,09 €
580-600	96,31 €
600-720	112,51 €

Koleno 90° (Corner elbows 90°)

Vonk. Ø na izolácii (mm):	Obj kód:	EUR/ks bez DPH
40	#2	2,83 €
48	#3	3,08 €
53	#4	3,25 €
63	#5	3,65 €
69	#6	4,25 €
79	#7	4,65 €
83	#8	4,94 €
90	#9	5,34 €
103	#10	6,44 €
115	#11	9,85 €
128	#12	14,41 €
139	#13	16,34 €
160	#14	21,85 €
169	#15	29,90 €

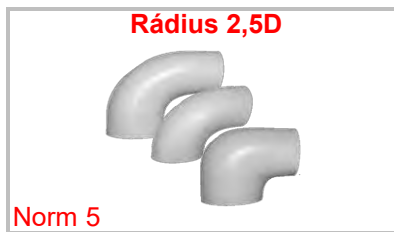

90° kolená (90° Bends Norm3: štandard 1,5d)

Vonk. Ø potrubia (mm):	EUR/ks bez DPH	1,5xD	1xD
Insulation Thickness = 9 mm			
18	2,98 €		E-W
22	2,98 €		E-W
Insulation Thickness = 13 mm			
12	3,08 €		E-W
15	3,08 €		E-W
18	3,08 €		E-W
22	3,08 €		E-W
28	4,14 €		E-W
35	4,14 €		E-W
Insulation Thickness = 20 mm			
12	3,16 €	E-S	
15	3,16 €		
18	3,16 €	E-S	E-W
22	3,16 €	E-S	E-W
28	4,31 €	E-S	E-W
35	4,31 €	E-S	E-W
42	4,76 €	E-S	E-W
48	4,76 €	E-S	E-W
54	6,49 €	E-S	E-W
60	6,49 €	E-S	E-W
64	8,13 €	E-S	
70	8,89 €	E-S	
76	8,89 €	E-S	E-W
89	10,58 €	E-S	E-W
102	13,71 €	E-S	
108	13,71 €	E-S	
114	20,26 €	E-S	E-W
Insulation Thickness = 25 mm			
18	4,31 €	E-S	E-W
22	4,31 €	E-S	E-W
28	4,35 €	E-S	E-W
35	4,76 €	E-S	E-W
42	4,76 €	E-S	E-W

Vonk. Ø potrubia (mm):	EUR/ks bez DPH	1,5xD	1xD
Insulation Thickness = 25 mm			
48	6,20 €	E-S	E-W
60	7,92 €	E-S	E-W
64	9,00 €		
70	9,00 €	E-S	
76	9,00 €	E-S	E-W
89	12,09 €	E-S	E-W
102	20,26 €	E-S	
108	20,26 €	E-S	
114	20,26 €	E-S	
133	23,43 €	E-S	
140	25,01 €	S-S	
159	26,82 €	S-S	
168	28,79 €	S-S	
219	52,16 €	S-S	
Insulation thickness = 30 mm			
18	4,35 €	E-S	E-W
22	4,76 €	E-S	E-W
28	4,76 €	E-S	E-W
35	4,76 €	E-S	E-W
42	6,30 €	E-S	E-W
48	6,49 €	E-S	E-W
54	9,00 €	E-S	
60	9,00 €	E-S	E-W
64	9,00 €	E-S	
70	10,94 €	E-S	E-W
76	10,94 €	E-S	E-W
89	13,71 €	E-S	E-W
102	20,26 €	E-S	
108	20,26 €	E-S	
114	22,55 €	E-S	E-W
127		E-S	
133	25,01 €	S-S	

Vonk. Ø potrubia (mm):	EUR/ks bez DPH	1,5xD	1xD
Insulation thickness = 30 mm			
140	26,82 €	S-S	
159	28,79 €	S-S	
168	31,81 €	S-S	
194	56,91 €	S-S	
219	56,91 €	S-S	
Insulation thickness = 40 mm			
18	6,69 €	E-S	E-W
22	6,69 €	E-S	E-W
28	7,92 €	E-S	E-W
35	9,00 €	E-S	E-W
42	10,58 €	E-S	E-W
48	10,58 €	E-S	E-W
54	13,71 €	E-S	
60	13,71 €	E-S	E-W
64	15,73 €	E-S	
70	15,73 €	E-S	
76	19,26 €	E-S	E-W
89	21,61 €	E-S	E-W
102	25,01 €	E-S	
108	25,01 €	E-S	
114	25,01 €	S-S	E-W
127			
133	28,79 €	S-S	
140	28,79 €	S-S	
159	31,81 €	S-S	
168	33,30 €	S-S	
194	62,11 €	S-S	
219	70,30 €	S-S	
Insulation thickness = 50 mm			
18	10,68 €	E-S	E-W
22	10,68 €	E-S	E-W
28	10,68 €	E-S	E-W

Vonk. Ø potrubia (mm):	EUR/ks bez DPH	1,5xD	1xD
Insulation thickness = 50 mm			
35	13,40 €	E-S	E-W
42	14,77 €	E-S	E-W
48	15,27 €	E-S	E-W
54	17,55 €	E-S	
60	17,79 €	E-S	E-W
64	19,95 €	E-S	
70	19,95 €	E-S	E-W
76	21,61 €	E-S	E-W
89	23,74 €	E-S	E-W
102	26,82 €	S-S	
108	26,82 €	S-S	
114	28,79 €	S-S	
127			
133	31,81 €	S-S	
140	33,30 €	S-S	
159	43,64 €	S-S	
168	47,36 €	S-S	
194	68,42 €	S-S	
219	76,46 €	S-S	
245	87,59 €	S-S	
267	94,93 €	S-S	
273	109,17 €	S-S	
324	147,03 €	S-S	
Insulation thickness = 60 mm			
35	17,33 €	E-S	
42	17,33 €	E-S	
48	18,91 €	E-S	
60	23,88 €	E-S	E-W
64	25,48 €	E-S	
70	28,91 €	E-S	
76	28,91 €	E-S	E-W
89	28,91 €	E-S	

Vonk. Ø potrubia (mm):	EUR/ks bez DPH	1,5xD	1xD
Insulation thickness = 60 mm			
102	31,81 €	S-S	
108	31,81 €	S-S	
114	32,42 €	S-S	
127		S-S	
133	43,64 €	S-S	
140	43,64 €	S-S	
159	51,80 €	S-S	
168	66,32 €	S-S	
194	74,03 €	S-S	
219	85,84 €	S-S	
Insulation thickness = 70 mm			
76	32,38 €	E-S	
Insulation thickness = 80 mm			
76	46,43 €	S-S	S-W
89	52,16 €	S-S	S-W
Insulation thickness = 100 mm			
35	49,77 €	S-S	
48			S-W
60	62,09 €	S-S	S-W
76	66,13 €	S-S	S-W
89	69,51 €	S-S	
108	70,29 €	S-S	
114	70,29 €	S-S	S-W
127			
133	77,50 €	S-S	
140	77,50 €	S-S	S-W
159	86,80 €	S-S	
168	94,90 €	S-S	S-W
194	111,38 €	S-S	
219	132,96 €	S-S	
245	144,63 €		
267	156,44 €	S-S	

EKATEC - pokovená PVC fólia (Isogenotec)

UV odolné tvarovky z PVC fólie kovovo lesklej farby (alternatíva povrchov SILVER CLAD, AL CLAD, ALU TEC a pod.). Používa sa ako povrchová ochrana izol. v interiéri a exteriéri.

PVC fólia v roli - kovovo leská (Plastic foil in rolls)

EKATEC / ISOGENOTEC®	Hr.	Šírka:	Bal.:	EUR/m2 bez DPH
	0,35mm	1,2m	30 m2	12,40 €

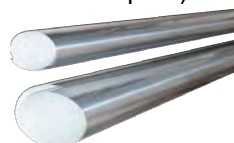

Vonk. Ø potrubia (mm):	90° kolená r=1,5d (90° Bends Norm3: 1,5d)									
	20 mm	25 mm	30 mm	40 mm	50 mm	60 mm	70 mm	80 mm	100 mm	
12	6,06 €									
18	6,06 €	6,93 €	7,83 €	12,34 €	18,60 €					
22	6,14 €	7,50 €	8,06 €	12,34 €	19,35 €					
28	6,41 €	8,04 €	9,58 €	12,69 €	20,12 €					
35	7,49 €	9,85 €	10,31 €	20,12 €	20,68 €	32,19 €				85,55 €
42	8,29 €	10,57 €	12,28 €	20,68 €	21,39 €	33,71 €		60,42 €		
48	10,97 €	11,83 €	12,97 €	21,14 €	27,67 €	35,01 €	46,53 €	62,91 €		
54	11,24 €		13,56 €		28,71 €					
57/60	11,83 €	15,34 €	15,87 €	23,69 €	33,78 €	35,21 €		62,91 €	94,09 €	
64	14,60 €		21,30 €		35,18 €	35,74 €				
70	20,68 €	21,36 €	22,03 €	31,84 €	38,30 €	36,95 €	47,81 €			
76	21,27 €	21,65 €	22,03 €	35,21 €	38,30 €	52,72 €	55,34 €	62,91 €	96,42 €	
89	22,14 €	25,95 €	30,19 €	35,74 €	40,73 €	55,66 €	62,91 €	74,49 €	98,34 €	
102	36,47 €	37,48 €	38,02 €	37,74 €	43,05 €					
108	38,78 €	40,21 €	40,73 €	48,81 €	54,86 €	68,44 €	74,22 €	90,56 €	102,92 €	
114	39,29 €	40,73 €	42,41 €	50,85 €	55,34 €	72,47 €		90,56 €	105,18 €	
133		65,54 €	68,22 €	88,83 €	90,56 €	99,91 €	93,12 €	116,27 €	108,20 €	
140		68,55 €	94,61 €	91,11 €	92,63 €	104,92 €		124,56 €	137,49 €	
159		75,89 €	97,31 €	92,84 €	95,60 €	110,72 €			148,05 €	
168		82,54 €	100,43 €	128,60 €	138,34 €	142,19 €		133,85 €	160,53 €	
194			106,16 €	140,88 €	140,88 €	143,45 €		175,93 €	176,15 €	
219		84,53 €	109,20 €	144,65 €	146,96 €	175,63 €		177,39 €	178,67 €	
245					175,63 €			178,67 €		
267					175,63 €			178,67 €	178,67 €	
273					175,63 €			178,67 €		



Koleno 90° (Corner elbows 90°)

Vonk. Ø na izolácii (mm):	Obj kód:	EUR/ks bez DPH
40	#2	5,77 €
48	#3	6,06 €
53	#4	6,29 €
63	#5	6,63 €
69	#6	7,37 €
79	#7	8,22 €
83	#8	9,64 €
90	#9	10,79 €
103	#10	12,48 €
115	#11	23,69 €
128	#12	35,21 €
139	#13	38,02 €
160	#14	50,85 €
169	#15	55,34 €

45° Kolená (45° Bends)

Vonk. Ø na izolácii (mm):	Použitie na izoláciu:	EUR/ks bez DPH
40	21-09	5,79 €
52	12-20	6,06 €
58	18-20	6,06 €
62	21-20	6,14 €
72	21-25	7,50 €
82	42-20	8,29 €
92	42-25	10,57 €
102	22-40	12,34 €
115	35-40	20,12 €
128	48-40	21,14 €
141	60-40	23,69 €
154	76-40	35,21 €
167	89-40	35,74 €
180	76-50	38,30 €
193	114-40	50,85 €
206	108-50	54,86 €
219	114-50	55,34 €
232	133-50	90,56 €
245	140-50	92,63 €
258	159-50	95,60 €
271	168-50	138,34 €

T-Kus 90° (Teas multi fit junction)

Vonk. Ø na izolácii (mm):	Priemer odbočky (mm):	EUR/ks bez DPH	Vonk. Ø na izolácii (mm):	Priemer odbočky (mm):	EUR/ks bez DPH
61	61-57	7,21 €	93	93-57	15,34 €
67	67-57	8,06 €	102	102-57	16,83 €
73	73-57	8,73 €	120	120-67	20,51 €
82	82-57	9,64 €	120	120-98	20,51 €
88	88-52	12,63 €	160	160-93	52,86 €



Celíčka (End caps)

Vonk. Ø na izolácii (mm):	EUR/ks bez DPH	Vonk. Ø na izolácii (mm):	EUR/ks bez DPH	Vonk. Ø na izolácii (mm):	EUR/ks bez DPH	Vonk. Ø na izolácii (mm):	EUR/ks bez DPH
60-70	7,42 €	110-130	11,53 €	210-250	21,45 €	400-440	61,24 €
70-80	7,64 €	130-150	13,14 €	250-290	39,35 €	440-480	61,83 €
80-90	7,83 €	150-170	14,87 €	290-330	46,00 €	480-530	105,47 €
90-100	8,43 €	170-190	16,58 €	330-360	50,57 €	530-580	129,43 €
100-110	9,30 €	190-210	18,32 €	360-400	58,12 €	580-600	138,17 €

EKAMAT- embasovaná AL fólia (Okatherm)

Tvarovky z hliníkovej fólie, embasovaný AL 99,5% (Kolená 90°, 45°, T kusy, púzdra na ventily).

Hrúbka 0,2 (na vyžiadanie 0,3mm).

AL fólia v roli - embasovaný hliníkový plech



EKAMAT / OKATHERM

Hr.	Šírka:	Bal.:	EUR/m2 bez DPH
0,2 mm	1 m	25 m2	10,20 €

Vonk. Ø potrubia (mm):	90° Kolená 1,5d (90° Bends Norm3: 1,5d)									
	13 mm	20 mm	25 mm	30 mm	35 mm	40 mm	50 mm	60 mm	80 mm	100 mm
12		7,12 €								
15	7,37 €			9,16 €						
18	7,37 €	7,37 €	7,96 €	9,16 €	9,35 €	10,46 €	12,51 €			
22	7,66 €	7,66 €	8,39 €	9,29 €	9,85 €	10,46 €	12,51 €			
28	7,96 €	7,96 €	9,29 €	9,35 €	10,46 €	10,64 €	14,97 €			
35	7,66 €	8,39 €	9,29 €	9,85 €	10,46 €	11,82 €	16,19 €		EUR/ks bez DPH	
38		9,29 €		10,46 €		12,51 €				
42/44	7,96 €	9,29 €	9,85 €	10,46 €	11,82 €	12,51 €	16,53 €	26,29 €		
48	8,39 €	9,35 €	10,46 €	10,64 €	11,82 €	14,97 €	21,89 €	26,29 €		
54				11,82 €	12,51 €	16,19 €	21,89 €	28,25 €		
57/60	9,29 €	10,46 €	10,64 €	11,82 €	14,97 €	16,19 €	21,89 €	28,25 €	43,66 €	
64		10,64 €	11,82 €	12,51 €	15,41 €	16,53 €	26,29 €	34,51 €	43,66 €	
70	10,46 €	10,64 €	11,82 €	14,97 €	16,19 €	21,89 €	26,29 €	34,51 €	48,06 €	
76		11,82 €	12,51 €	15,41 €	21,37 €	21,89 €	28,25 €	34,51 €	48,06 €	
89		14,97 €	15,41 €	21,37 €	23,84 €	26,29 €	34,51 €	34,83 €	51,97 €	63,02 €
102		21,37 €	23,84 €	23,84 €	26,29 €	34,51 €	34,83 €	43,66 €	56,82 €	
108		21,37 €	23,84 €	26,29 €	28,25 €	34,51 €	34,83 €	43,66 €	56,82 €	75,92 €
114		23,84 €	26,29 €	28,25 €	34,51 €	34,51 €	45,45 €	48,06 €	67,03 €	75,92 €
127		26,29 €	28,25 €	34,51 €	34,51 €	34,83 €	43,66 €	51,09 €	73,71 €	
133		28,25 €	34,51 €	34,51 €	34,83 €	39,83 €	48,06 €	53,23 €	75,92 €	79,48 €
140		34,51 €	34,51 €	34,83 €		45,45 €	51,09 €	54,54 €	75,92 €	85,88 €
159		34,51 €	34,83 €	45,45 €		51,09 €	54,54 €	67,03 €	79,48 €	88,65 €
169			45,45 €	43,66 €		51,09 €	55,90 €	73,71 €	85,88 €	

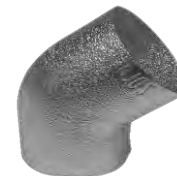

Kolená 45° (Bends 45°0,2mm)

Vonk. Ø na izol. (mm):	Použitie na izoláciu:	EUR/ks bez DPH
62	21-20	7,22 €
72	33-20	7,41 €
82	42-20	8,02 €
88	28-30	8,02 €
95	33-30	8,02 €
102	42-30	9,59 €
108	48-30	9,59 €
115	35-40	9,59 €
122	42-40	9,59 €
128	48-40	9,59 €
141	62-40	10,87 €
154	76-40	11,44 €
167	89-40	14,10 €
184	60-60	15,01 €
193	114-40	15,82 €
215	114-50	18,66 €
236	114-60	21,32 €
258	159-50	24,80 €
300	194-50	28,12 €
345	140-100	44,26 €

T-Kus 90° (Tees 0,2mm)

Vonk. Ø na izol. (mm):	EUR/ks bez DPH
58	7,22 €
62	7,41 €
68	8,02 €
68	8,02 €
75	9,59 €
81	9,59 €
84	9,59 €
87	9,85 €
95	10,74 €
104	10,74 €
108	11,01 €



DN	EKAMAT Boxes púzdra na ventily (hr.0,2mm)			Box-šikmý ventil	Box-kolmý ventil	Box-guľový ventil	Box-komb. ventilov
	Použitie pre potrubie:			EUR/ks bez DPH	EUR/ks bez DPH	EUR/ks bez DPH	EUR/ks bez DPH
	Fe	Cu	Hr. izol.				
15	21	18	20-27	34,56 €	29,49 €	29,49 €	37,32 €
20	27	22	20-31	37,32 €	32,68 €	32,68 €	42,61 €
25	34	28	30-38	42,61 €	38,98 €	38,98 €	51,17 €
32	42	35	30-45	51,17 €	45,97 €	45,97 €	
40	48	42	40-48	58,76 €	49,79 €	49,79 €	
50	60	54	50-59	78,79 €	61,67 €	61,67 €	

Príslušenstvo k PVC povrchom

(Ekafol, Isogenopak, Okapak, Ekatec, Isogenotec, ArmaChek Silver, Kaiflex Protect ALuTec, AL Clad a pod.)

P.č.	Položka	Popis	MJ	EUR/MJ bez DPH
1	PVC šedá páska 25m x 25mm	PVC-self adhesive tape grey, width 25 mm, length 25 m	ks	8,00 €
2	PVC šedá páska 25m x 30mm	PVC-self adhesive tape grey, width 30 mm, length 25 m	ks	8,00 €
3	PVC biela páska 33m x 30mm	PVC-self adhesive tape white, width 30 mm, length 33 m	ks	9,40 €
4	SILVER CLAD páska do exteriéru 25m x 19mm	EKAFIX self adhesive tape silver, width 19 mm, length 25 m	ks	7,70 €
5	SILVER CLAD páska do exteriéru 25m x 25mm	EKAFIX self adhesive tape silver, width 25 mm, length 25 m	ks	10,10 €
6	SILVER CLAD páska do exteriéru 30m x 25mm	EKAFIX self adhesive tape, silver, width 30 mm, length 25 m	ks	12,10 €
7	SILVER CLAD páska do exteriéru 50m x 50mm	EKAFIX self adhesive tape, silver, width 50 mm, length 50 m	ks	40,70 €
8	EKAFIX hladítko na pásky	EKAFIX spatula for tapes	ks	2,90 €
9	EKAFIX plastové nity biele alebo šedé (1000ks/bal.)	EKAFIX PVC rivets white and grey	bal	8,15 €
10	EKAFIX nitovač rovný / bočný	EKAFIX tool for rivet strait / angle	ks	5,60 €
11	EKAFIX nitovač kombinovaný	EKAFIX tool for rivet combination of strait and angle	ks	5,60 €
12	EKAFIX nitovač kombinovaný PREMIUM	EKAFIX rivet tool PREMIUM combination of strait and angle	ks	12,20 €
13	Rezací stôl 1 m	EKAFIX cutting table, 1 m width, for PVC-roles	ks	909 €
14	Rezací stôl 1,2 m	EKAFIX cutting table, 1,2 m width for PVC-Roles	ks	1 081 €
15	Rezací stôl 1,4 m	EKAFIX cutting table, 1,4 m width for PVC-Roles	ks	1 207 €
16	EKAFIX nohy pre rezací stôl	EKAFIX legs for EKAFIX – cutting table	ks	443 €
17	EKAFIX príložník/pravítko 1 m	EKAFIX measure profile for cutting table 1 m	ks	103 €
18	EKAFIX príložník/pravítko 1,2 m	EKAFIX measure profile for cutting table 1,2 m	ks	109 €
19	EKAFIX príložník/pravítko 1,4 m	EKAFIX measure profile for cutting table 1,4 m	ks	114 €
20	EKAFIX rotačný nôž	EKAFIX Role knife	ks	123 €
21	EKAFIX náhradne čepele pre rotačný nôž	EKAFIX Role knif- blade	ks	47 €
22	Nôž 6"	EKAFIX knife for insulation material, 6"	ks	20 €
23	Nožnice 9"	EKAFIX scissors , 9"	ks	42 €

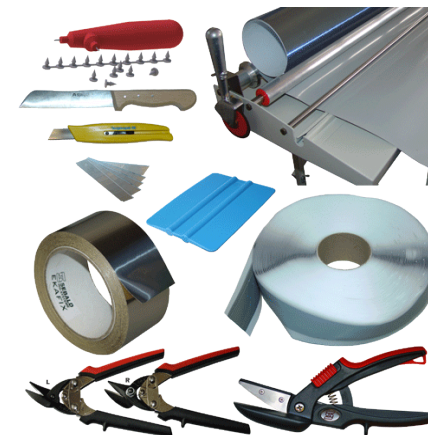

Príslušenstvo k AL embasovanému plechu

(Ekamat, Okatherm)

P.č.	Položka	Popis	MJ	EUR/MJ bez DPH
1	Nitovač pre kovové nity	EKAFIX tool for metal rivets	ks	53,50 €
2	Kovové nity (100ks/bal.)	EKAFIX rivets, stainless steel	bal	70,80 €
3	Sponkovačka	EKAFIX tacker for jacketing system	ks	207,20 €
4	Zásobník do sponkovačky	EKAFIX nose for tacker L4C5	ks	30,10 €
5	Sponky 15mm nerezové (5000ks/bal.)	EKAFIX staples 1/2" for EKAFIX tacker	bal.	99,60 €
6	Sponky 22mm pozinkované (5000ks/bal.)	EKAFIX staples 3/8" for EKAFIX tracker	bal.	30,10 €
7	Sponkovačka SpreDEX 7	EKAFIX tacker	ks	129,10 €
8	Sponky 10mm pozinkované (5000ks/bal.)	EKAFIX staples 11/10mm for tacker SpreDEX 7 (galvanized)	bal.	20,30 €
9	Plastové nity (1000ks/bal.)	EKAFIX plastic rivets for EKAMAT	bal	23,50 €
10	Nitovač k plastovým nitom	EKAFIX tool, straight or angled for plastic rivets	ks	7,50 €

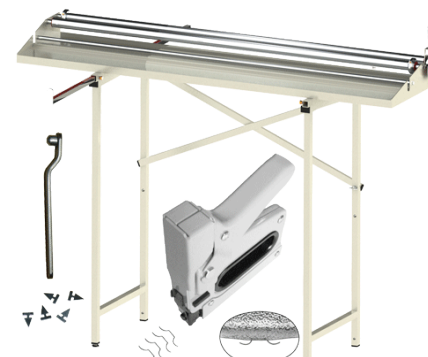

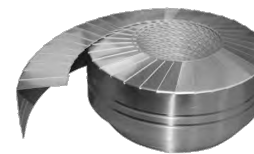
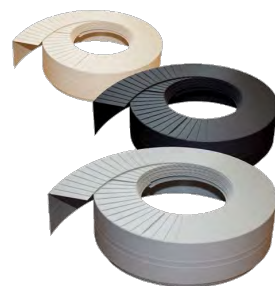
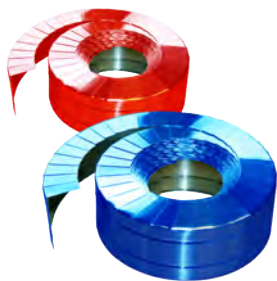
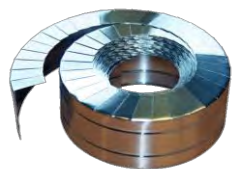

EKALIT	AL- ukončovacie pásky					
	čistá (AL)		šedá		červená modrá	
Šírka (mm)	EUR/bm bez DPH	EUR/ks bez DPH	EUR/bm bez DPH	EUR/ks bez DPH	EUR/bm bez DPH	EUR/ks bez DPH
10	3,40 €	34 €	3,85 €	39 €		
15	3,40 €	34 €	3,85 €	39 €		
20	3,40 €	34 €	3,85 €	39 €	4,40 €	44 €
25	3,85 €	39 €	4,40 €	44 €	4,70 €	47 €
30	3,85 €	39 €	4,40 €	44 €	4,70 €	47 €
40	5,30 €	53 €	6,10 €	61 €	6,70 €	67 €
50	6,00 €	60 €	7,15 €	72 €	7,95 €	80 €
60	6,85 €	69 €	8,55 €	86 €	9,05 €	91 €
70	7,95 €	80 €	9,60 €	96 €		
80	9,05 €	91 €	11,00 €	110 €		
100	11,50 €	115 €	13,50 €	135 €		

1ks =10bm (v kartóne celkom 5ks)

EKATEC	PVC - ukončovacie pásky			
	šedá čierna biela		EKATEC (kovovo lesklá)	
Šírka (mm)	EUR/bm bez DPH	EUR/ks bez DPH	EUR/bm bez DPH	EUR/ks bez DPH
10				
15	4,40 €	22,00 €	9,60 €	48,00 €
20	4,40 €	22,00 €	9,60 €	48,00 €
25	4,70 €	23,50 €	10,70 €	53,50 €
30	4,70 €	23,50 €	10,70 €	53,50 €
40	6,70 €	33,50 €	12,75 €	63,75 €
50	7,95 €	39,75 €	13,80 €	69,00 €

1ks =5bm (v kartóne celkom 5ks)

Oplechovanie EKAMET / OKABELL

Pozink. plech (Galvanized steel)

Hliníková plech odolný voči morskéj vode (Aluminum seawater resistant)

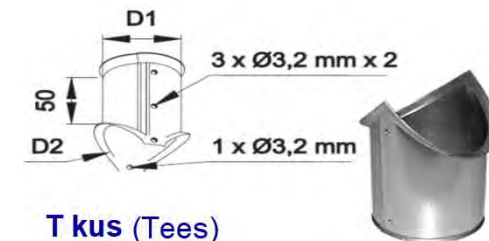
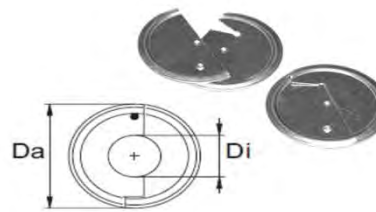
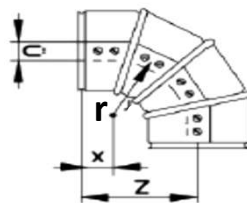
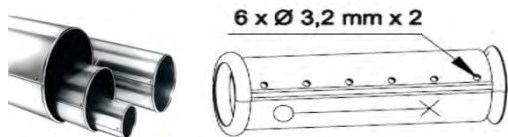

Rovný kus 1m (Straight jackets)

Ø (mm)	Pozinkovaný plech		Hliníkový plech	
	Hr. (mm)	EUR/ks bez DPH	Hr. (mm)	EUR/ks bez DPH
70	0,4	17 €	0,5	21 €
80	0,4	18 €	0,5	22 €
90	0,4	19 €	0,5	24 €
100	0,4	20 €	0,5	25 €
110	0,5	23 €	0,5	27 €
120	0,5	24 €	0,5	28 €
130	0,5	26 €	0,6	32 €
140	0,5	28 €	0,6	35 €
150	0,5	29 €	0,6	37 €
160	0,6	35 €	0,6	39 €
170	0,6	37 €	0,6	41 €
180	0,6	39 €	0,6	43 €
190	0,6	40 €	0,6	45 €
200	0,6	42 €	0,6	47 €
210	0,6	44 €	0,6	50 €
220	0,6	45 €	0,6	52 €
230	0,6	47 €	0,6	54 €
240	0,6	48 €	0,6	57 €
250	0,6	50 €	0,6	59 €
260	0,7	59 €	0,8	83 €
270	0,7	61 €	0,8	86 €
280	0,7	63 €	0,8	88 €
290	0,7	65 €	0,8	91 €
300	0,7	67 €	0,8	94 €
310	0,7	70 €	0,8	97 €
320	0,7	72 €	0,8	99 €
330	0,7	74 €	0,8	102 €
340	0,7	76 €	0,8	105 €
350	0,7	78 €	0,8	107 €
360	0,7	80 €	0,8	110 €
370	0,7	82 €	0,8	112 €
380	0,7	84 €	0,8	117 €

Kolená 90° (Segment-bends)

Ø (mm)	Rádus r (mm)	Segmentov (ks):	Pozinkovaný plech		Hliníkový plech	
			Hr. (mm)	EUR/ks bez DPH	Hr. (mm)	EUR/ks bez DPH
70	55	4	0,5	12 €	0,5	15 €
80	60	4	0,5	13 €	0,5	15 €
90	60	4	0,5	13 €	0,5	16 €
100	70	4	0,5	14 €	0,5	17 €
110	70	4	0,5	15 €	0,5	18 €
120	80	4	0,5	16 €	0,5	19 €
130	80	4	0,6	17 €	0,6	20 €
140	90	4	0,6	18 €	0,6	21 €
150	90	4	0,6	19 €	0,6	22 €
160	95	4	0,6	20 €	0,6	23 €
170	100	4	0,6	23 €	0,6	27 €
180	110	4	0,6	24 €	0,6	28 €
190	110	4	0,6	25 €	0,6	30 €
200	125	4	0,6	26 €	0,6	31 €
210	120	4	0,6	28 €	0,6	32 €
220	130	4	0,6	29 €	0,6	34 €
230	130	4	0,6	30 €	0,6	36 €
240	145	4	0,6	32 €	0,6	38 €
250	155	4	0,6	35 €	0,6	41 €
260	160	4	0,7	41 €	0,8	51 €
270	170	4	0,7	43 €	0,8	53 €
280	175	4	0,7	44 €	0,8	55 €
290	180	4	0,7	46 €	0,8	58 €
300	185	4	0,7	48 €	0,8	60 €
310	190	4	0,7	50 €	0,8	62 €
320	190	4	0,7	52 €	0,8	65 €
330	195	4	0,7	53 €	0,8	67 €
340	200	4	0,7	56 €	0,8	70 €
350	210	4	0,7	59 €	0,8	74 €
360	215	4	0,7	62 €	0,8	78 €
370	230	4	0,7	68 €	0,8	85 €
380	270	5	0,7	74 €	0,8	92 €

Čelička (End caps)

Ø (mm)	Pozinkovaný plech		Hliníkový plech	
	Ø (mm)	EUR/ks bez DPH	Ø (mm)	EUR/ks bez DPH
70	70	4,8 €	70	5,70 €
80	80	5,0 €	80	5,80 €
90	90	5,2 €	90	6,00 €
100	100	5,3 €	100	6,20 €
110	110	5,6 €	110	6,40 €
120	120	5,7 €	120	6,50 €
130	130	5,9 €	130	6,70 €
140	140	6,1 €	140	6,90 €
150	150	6,3 €	150	7,20 €
160	160	6,5 €	160	7,40 €
170	170	6,8 €	170	7,70 €
180	180	7,1 €	180	7,90 €
190	190	7,7 €	190	8,80 €
200	200	8,3 €	200	9,30 €
210	210	8,7 €	210	10 €
220	220	9,2 €	220	10 €
230	230	10 €	230	11 €
240	240	10 €	240	11 €
250	250	11 €	250	14 €
260	260	12 €	260	14 €
270	270	12 €	270	15 €
280	280	13 €	280	16 €
290	290	13 €	290	17 €
300	300	14 €	300	17 €
310	310	15 €	310	18 €
320	320	16 €	320	19 €
330	330	16 €	330	20 €
340	340	17 €	340	21 €
350	350	18 €	350	22 €
360	360	19 €	360	23 €
370	370	20 €	370	24 €
380	380	20 €	380	25 €

T kus (Tees)

Ø (mm)	Pozinkovaný plech		Hliníkový plech	
	Hr. (mm)	EUR/ks bez DPH	Hr. (mm)	EUR/ks bez DPH
70	0,5	27 €	0,6	29 €
80	0,5	28 €	0,6	31 €
90	0,5	30 €	0,6	33 €
100	0,5	32 €	0,6	35 €
110	0,5	33 €	0,6	37 €
120	0,5	35 €	0,6	39 €
130	0,6	38 €	0,8	43 €
140	0,6	40 €	0,8	45 €
150	0,6	42 €	0,8	47 €
160	0,6	44 €	0,8	49 €
170	0,6	46 €	0,8	52 €
180	0,6	48 €	0,8	54 €
190	0,6	49 €	0,8	56 €
200	0,6	53 €	0,8	59 €
210	0,6	55 €	0,8	61 €
220	0,6	57 €	0,8	64 €
230	0,6	59 €	0,8	66 €
240	0,6	61 €	0,8	69 €
250	0,6	63 €	0,8	72 €
260	0,7	65 €	1	75 €
270	0,7	70 €	1	77 €
280	0,7	72 €	1	80 €
290	0,7	74 €	1	82 €
300	0,7	76 €	1	85 €

Ø (mm)	Pozinkovaný plech		Hliníkový plech		Ø (mm)	Rádus r (mm)	Segmentov (ks):	Pozinkovaný plech		Hliníkový plech		Pozinkovaný plech		Hliníkový plech	
	Hr. (mm)	EUR/ks bez DPH	Hr. (mm)	EUR/ks bez DPH				Hr. (mm)	EUR/ks bez DPH	Hr. (mm)	EUR/ks bez DPH	Ø (mm)	EUR/ks bez DPH	Ø (mm)	EUR/ks bez DPH
390	0,7	89 €	0,8	120 €	390	270	5	0,7	81 €	0,8	99 €	390	21 €	390	26 €
400	0,7	92 €	0,8	123 €	400	280	5	0,7	86 €	0,8	106 €	400	22 €	400	27 €
410	0,7	94 €	0,8	126 €	410	280	5	0,7	91 €	0,8	113 €	410	23 €	410	28 €
420	0,7	96 €	0,8	129 €	420	305	5	0,7	94 €	0,8	118 €	420	24 €	420	29 €
430	0,7	98 €	0,8	132 €	430	310	5	0,7	97 €	0,8	122 €	430	25 €	430	31 €
440	0,7	100 €	0,8	134 €	440	320	6	0,7	100 €	0,8	126 €	440	25 €	440	32 €
450	0,7	102 €	0,8	137 €	450	330	6	0,7	104 €	0,8	131 €	450	26 €	450	33 €
460	0,7	104 €	0,8	140 €	460	340	6	0,7	107 €	0,8	137 €	460	27 €	460	34 €
470	0,7	106 €	0,8	143 €	470	360	6	0,7	112 €	0,8	143 €	470	28 €	470	35 €
480	0,7	108 €	0,8	146 €	480	380	6	0,7	116 €	0,8	150 €	480	29 €	480	37 €

Základné údaje oplechovania pre objednávku:

Rovný kus

Por. č.	Plech:	Typ (štandard pozitív -negatív):	Hr. (mm)	Ø (mm)		Dĺžka (mm)	Počet ks:

Štandard rovných kusov:
6x prevrtanie, dĺžka 1000mm,
olemovanie (pozitív - negatív):

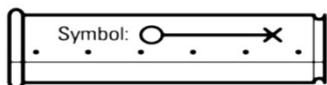

Koleno

Por. č.	Plech:	Typ (štandard 90° E4 C):	Hr. (mm)	Ø (mm)	r (mm):	Segmentov (ks)	Počet ks:

Štandard kolien: dierovanie,
olemovanie E4 (C) (negatív-negatív)

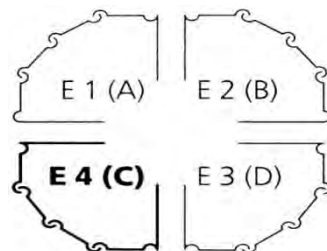

Čeličko, T-Kus alebo zúženie.

Por. č.	Plech:	Typ:	Hr. (mm)	Ø Da / D1 mm	Ø Di / D2 (mm)	Dĺžka (mm):	Počet ks:

Oplechovanie EKAMET / OKABELL

Kryt na príruby (Flange box)

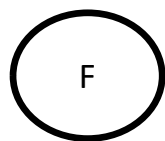

Kryt jednoduchý (Case box)

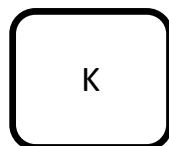

Kryt na ventil (Valve box)

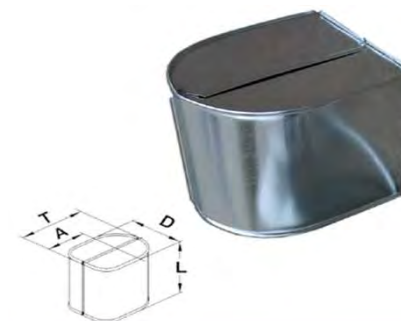
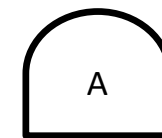

Pozink. plech (Galvanized steel)

D (mm)	2 x D (mm)	Hr. (mm)	Výška L:			
			300mm	500mm	750mm	980mm
			EUR/ks bez DPH	EUR/ks bez DPH	EUR/ks bez DPH	EUR/ks bez DPH
150	300	0,6	69 €	71 €	77 €	90 €
160	320	0,6	71 €	73 €	79 €	94 €
170	340	0,6	72 €	75 €	82 €	98 €
175	350	0,6				
180	360	0,6	73 €	78 €	85 €	101 €
190	380	0,6				
200	400	0,6	77 €	83 €	91 €	110 €
205	410	0,6				
210	420	0,6	79 €	85 €	94 €	113 €
215	430	0,6				
220	440	0,6	81 €	88 €	97 €	117 €
230	460	0,6	83 €	90 €	100 €	121 €
235	470	0,6				
240	480	0,6	85 €	92 €	103 €	125 €
250	500	0,6	87 €	95 €	106 €	127 €
260	520	0,6				
270	540	0,7	92 €	104 €	118 €	138 €
285	570	0,7				
290	580	0,7	99 €	110 €	125 €	146 €
300	600	0,7	100 €	112 €	127 €	150 €
310	620	0,7				
320	640	0,7	105 €	117 €	134 €	157 €
330	660	0,7				
340	680	0,7				
350	700	0,7	112 €	126 €	144 €	170 €
360	720	0,7	114 €	128 €	146 €	173 €
375	750	0,7				
380	760	0,7				
400	800	0,8	131 €	149 €	172 €	191 €
410	820	0,8	132 €	151 €	175 €	193 €
420	840	0,8	133 €	153 €	177 €	200 €

Pozink. plech (Galvanized steel)

D + T (mm)	Hr. (mm)	Výška L:			
		300mm	500mm	750mm	980mm
		EUR/ks bez DPH	EUR/ks bez DPH	EUR/ks bez DPH	EUR/ks bez DPH
300	0,6				
320	0,6	69 €	75 €	83 €	92 €
340	0,6				
350	0,6	70 €	77 €	87 €	95 €
360	0,6				
380	0,6	72 €	80 €	90 €	99 €
400	0,6				
410	0,6	74 €	83 €	93 €	104 €
420	0,6				
430	0,6				
440	0,6	76 €	86 €	98 €	108 €
460	0,6				
470	0,6	78 €	88 €	101 €	113 €
480	0,6				
500	0,6	80 €	91 €	104 €	118 €
520	0,6				
540	0,7	95 €	108 €	126 €	142 €
570	0,7				
580	0,7	99 €	113 €	131 €	148 €
600	0,7				
620	0,7	103 €	118 €	137 €	155 €
640	0,7				
660	0,7	106 €	123 €	143 €	162 €
680	0,7				
700	0,7	109 €	127 €	149 €	169 €
720	0,7				
750	0,7	114 €	133 €	156 €	178 €
760	0,7				
800	0,8	123 €	145 €	172 €	197 €
820	0,8				
840	0,8				

Pozink. plech (Galvanized steel)





D + T (mm)	Hr. (mm)	Výška L:			
		300mm	500mm	750mm	980mm
		EUR/ks bez DPH	EUR/ks bez DPH	EUR/ks bez DPH	EUR/ks bez DPH
300	0,6				
320	0,6				
340	0,6	81 €	87 €	95 €	103 €
350	0,6				
360	0,6				
380	0,6	83 €	90 €	100 €	109 €
400	0,6				
410	0,6	85 €	93 €	103 €	113 €
420	0,6				
430	0,6	87 €	95 €	106 €	116 €
440	0,6				
460	0,6	101 €	110 €	122 €	133 €
470	0,6				
480	0,6	102 €	112 €	124 €	135 €
500	0,6	104 €	114 €	126 €	138 €
520	0,6	105 €	115 €	129 €	142 €
540	0,7	107 €	117 €	130 €	143 €
570	0,7	113 €	126 €	142 €	158 €
580	0,7				
600	0,7	116 €	130 €	147 €	163 €
620	0,7				
640	0,7	125 €	139 €	158 €	175 €
660	0,7				
680	0,7	128 €	144 €	164 €	183 €
700	0,7				
720	0,7	131 €	169 €	174 €	188 €
750	0,7				
760	0,7	134 €	152 €	173 €	195 €
800	0,8	136 €	166 €	190 €	215 €
820	0,8				
840	0,8				

Pozink. plech (Galvanized steel)						
D (mm)	2 x D (mm)	Hr. (mm)	Výška L:			
			300mm EUR/ks bez DPH	500mm EUR/ks bez DPH	750mm EUR/ks bez DPH	980mm EUR/ks bez DPH
425	850	0,8				
450	900	0,8	141 €	162 €	188 €	213 €
470	940	0,8	146 €	168 €	195 €	221 €
475	950	0,8				
480	960	0,8	147 €	169 €	197 €	224 €
500	1000	0,8	151 €	175 €	204 €	231 €
510	1020	0,8				
530	1060	0,8				
550	1100	0,8				
580	1160	0,8				
625	1250	0,8				
750	1500	0,8				

Pozink. plech (Galvanized steel)						
D + T (mm)	Hr. (mm)	Výška L:				
		300mm EUR/ks bez DPH	500mm EUR/ks bez DPH	750mm EUR/ks bez DPH	980mm EUR/ks bez DPH	
850	0,8	137 €	160 €	188 €	216 €	
900	0,8	142 €	166 €	198 €	226 €	
940	0,8					
950	0,8	148 €	174 €	206 €	235 €	
960	0,8					
1000	0,8					
1020	0,8					
1060	0,8	160 €	189 €	226 €	258 €	
1100	0,8					
1160	0,8	161 €	203 €	241 €	279 €	
1250	0,8	186 €	222 €	267 €	308 €	
1500	0,8	233 €	275 €	330 €	381 €	

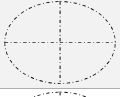
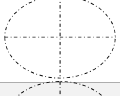
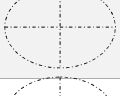
Pozink. plech (Galvanized steel)						
D + T (mm)	Hr. (mm)	Výška L:				
		300mm EUR/ks bez DPH	500mm EUR/ks bez DPH	750mm EUR/ks bez DPH	980mm EUR/ks bez DPH	
850	0,8	150 €	171 €	199 €	223 €	
900	0,8	155 €	179 €	207 €	233 €	
940	0,8					
950	0,8	161 €	186 €	216 €	243 €	
960	0,8					
1000	0,8					
1020	0,8	190 €	247 €	252 €	282 €	
1060	0,8					
1100	0,8	201 €	231 €	267 €	299 €	
1160	0,8					
1250	0,8					
1500	0,8					

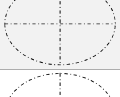
Základné údaje oplechovania (BOXov) pre objednávku:

Por. č.	Plech:	Typ. (F,K,A):	Rozdelenie:	Hrúbka:	D Šírka (mm)	T Hĺbka (mm) (T= A+D/2)	A vzdial. od osi (mm)	L výška (mm) (lem +12mm)	Počet ks:
									
									
									
									
									
									
									

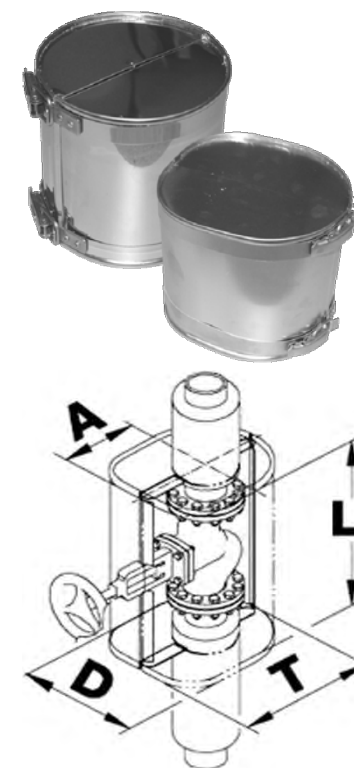

Oplechovanie EKAMET / OKABELL

Kryt na príruby (Flange box)

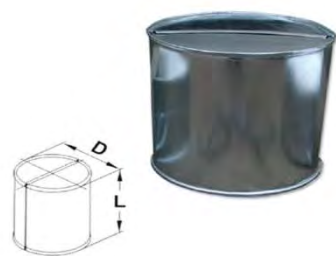
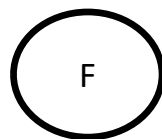

Kryt jednoduchý (Case box)

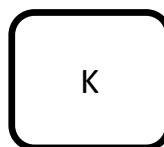

Kryt na ventil (Valve box)

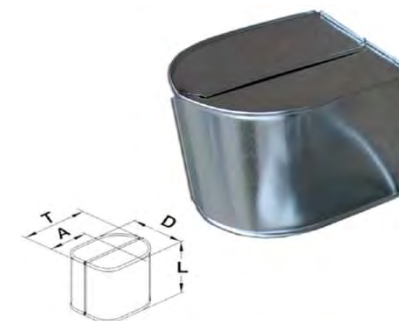
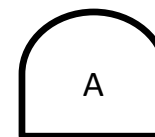

Hliník. plech (Aluminum seawater resistant)

D (mm)	2 x D (mm)	Hr. (mm)	Výška L:			
			300mm	500mm	750mm	980mm
			EUR/ks bez DPH	EUR/ks bez DPH	EUR/ks bez DPH	EUR/ks bez DPH
150	300	0,6	75 €	78 €	85 €	104 €
160	320	0,6	76 €	80 €	88 €	108 €
170	340	0,6	78 €	83 €	91 €	112 €
175	350	0,6				
180	360	0,6	79 €	85 €	94 €	117 €
190	380	0,6				
200	400	0,6	84 €	91 €	101 €	126 €
205	410	0,6				
210	420	0,6	86 €	94 €	105 €	130 €
215	430	0,6				
220	440	0,6	88 €	96 €	108 €	138 €
230	460	0,6	90 €	99 €	111 €	143 €
235	470	0,6				
240	480	0,6	92 €	101 €	114 €	147 €
250	500	0,6	94 €	104 €	117 €	152 €
260	520	0,6				
270	540	0,8	109 €	124 €	144 €	162 €
285	570	0,8				
290	580	0,8	115 €	131 €	152 €	172 €
300	600	0,8	117 €	134 €	156 €	176 €
310	620	0,8				
320	640	0,8	123 €	141 €	164 €	186 €
330	660	0,8				
340	680	0,8				
350	700	0,8	132 €	152 €	178 €	201 €
360	720	0,8	134 €	155 €	179 €	205 €
375	750	0,8				
380	760	0,8				
400	800	0,8	147 €	170 €	200 €	227 €
410	820	0,8	149 €	173 €	203 €	231 €
420	840	0,8	151 €	175 €	206 €	235 €

Hliník. plech (Aluminum seawater resistant)

D + T (mm)	Hr. (mm)	Výška L:			
		300mm	500mm	750mm	980mm
		EUR/ks bez DPH	EUR/ks bez DPH	EUR/ks bez DPH	EUR/ks bez DPH
300	0,6				
320	0,6	74 €	79 €	89 €	98 €
340	0,6				
350	0,6	77 €	85 €	96 €	106 €
360	0,6				
380	0,6	79 €	88 €	100 €	111 €
400	0,6				
410	0,6	81 €	91 €	104 €	115 €
420	0,6				
430	0,6				
440	0,6	83 €	95 €	108 €	121 €
460	0,6				
470	0,6	86 €	97 €	112 €	126 €
480	0,6				
500	0,6	88 €	100 €	115 €	130 €
520	0,6				
540	0,7	109 €	127 €	149 €	169 €
570	0,7				
580	0,7	113 €	133 €	156 €	179 €
600	0,7				
620	0,7	118 €	139 €	164 €	186 €
640	0,7				
660	0,7	123 €	145 €	171 €	195 €
680	0,7				
700	0,7	127 €	150 €	178 €	204 €
720	0,7				
750	0,7	133 €	157 €	188 €	215 €
760	0,7				
800	0,8	139 €	164 €	196 €	226 €
820	0,8				
840	0,8				

Hliník. plech (Aluminum seawater resistant)

D + T (mm)	Hr. (mm)	Výška L:			
		300mm	500mm	750mm	980mm
		EUR/ks bez DPH	EUR/ks bez DPH	EUR/ks bez DPH	EUR/ks bez DPH
300	0,6				
320	0,6				
340	0,6	88 €	95 €	105 €	114 €
350	0,6				
360	0,6				
380	0,6	90 €	99 €	110 €	120 €
400	0,6				
410	0,6	94 €	102 €	114 €	125 €
420	0,6				
430	0,6	95 €	104 €	117 €	128 €
440	0,6				
460	0,6	110 €	120 €	134 €	146 €
470	0,6				
480	0,6	111 €	122 €	136 €	149 €
500	0,6	113 €	126 €	141 €	155 €
520	0,6	114 €	127 €	144 €	158 €
540	0,8	115 €	128 €	146 €	161 €
570	0,8	129 €	144 €	168 €	188 €
580	0,8				
600	0,8	133 €	146 €	174 €	195 €
620	0,8				
640	0,8	143 €	163 €	187 €	208 €
660	0,8				
680	0,8	147 €	168 €	194 €	218 €
700	0,8				
720	0,8	152 €	173 €	200 €	224 €
750	0,8				
760	0,8	155 €	178 €	206 €	231 €
800	0,8	161 €	187 €	218 €	244 €
820	0,8				
840	0,8				

Hliník. plech (Aluminum seawater resistant)						
D (mm)	2 x D (mm)	Hr. (mm)	Výška L:			
			300mm EUR/ks bez DPH	500mm EUR/ks bez DPH	750mm EUR/ks bez DPH	980mm EUR/ks bez DPH
425	850	0,8				
450	900	0,8	160 €	187 €	220 €	250 €
470	940	0,8	166 €	194 €	228 €	260 €
475	950	0,8				
480	960	0,8	168 €	196 €	231 €	264 €
500	1000	0,8	173 €	209 €	239 €	273 €
510	1020	0,8				
530	1060	0,8				
550	1100	0,8				
580	1160	0,8				
625	1250	0,8				
750	1500	0,8				

Hliník. plech (Aluminum seawater resistant)					
D + T (mm)	Hr. (mm)	Výška L:			
		300mm EUR/ks bez DPH	500mm EUR/ks bez DPH	750mm EUR/ks bez DPH	980mm EUR/ks bez DPH
850	0,8	153 €	182 €	215 €	247 €
900	0,8	161 €	189 €	227 €	258 €
940	0,8				
950	0,8	167 €	197 €	236 €	272 €
960	0,8				
1000	0,8				
1020	0,8				
1060	0,8	182 €	217 €	258 €	296 €
1100	0,8				
1160	0,8	194 €	232 €	293 €	320 €
1250	0,8	219 €	264 €	320 €	372 €
1500	0,8	273 €	328 €	397 €	460 €

Hliník. plech (Aluminum seawater resistant)					
D + T (mm)	Hr. (mm)	Výška L:			
		300mm EUR/ks bez DPH	500mm EUR/ks bez DPH	750mm EUR/ks bez DPH	980mm EUR/ks bez DPH
850	0,8	174 €	194 €	226 €	256 €
900	0,8	175 €	202 €	236 €	266 €
940	0,8				
950	0,8	181 €	210 €	244 €	277 €
960	0,8				
1000	0,8				
1020	0,8	214 €	256 €	286 €	323 €
1060	0,8				
1100	0,8	226 €	263 €	304 €	343 €
1160	0,8				
1250	0,8				
1500	0,8				

Základné údaje oplechovania (BOXov) pre objednávku:

Por. č.	Plech:	Typ. (F,K,A):	Rozdelenie:	Hrúbka:	D Šírka (mm)	T Hĺbka (mm) (T= A+D/2)	A vzdial. od osi (mm)	L výška (mm) (lem +12mm)	Počet ks:

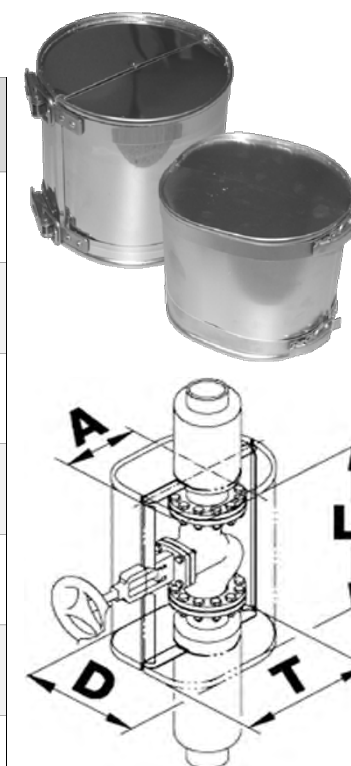

Oplechovanie- spojovací materiál a príslušenstvo

V ponuke je široký sortiment skrutiek, nitov, praciek a rôznych klampiarskych prvkov potrebných k realizácii oplechovania, vrátane náradia a montážnych pomôcok. Ceny na vyžiadanie.

Skrutka		
Kvalita	Nerez (V2A AISI 304)	Pozink
Variant	Bez podložky	
	Podložka polyamid	
	Podložka EPDM (3x12)	
Priemer	4,2 / 4,8	
Dĺžka	9,5 / 13 / 16 / 19	

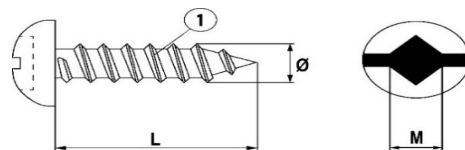

Skrutka samovrtná		
Kvalita	DIN 7504	
	Nerez V2A (AISI 304)	Pozink
Variant	Bez podložky	
	Podložka EPDM (3x12)	
Priemer	4,2 / 4,8	
Dĺžka	13 / 16 / 19	

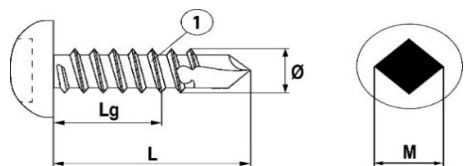

Skrutka		
Kvalita	DIN 7976 (ISO 1479)	
	Nerez V2A+GZ (AISI 304)	Nerez (V2A AISI 304)
Variant	Bez podložky	
	Podložka polyamid	
	Podložka nerez + EPDM	
Priemer	4,2 / 4,8	
Dĺžka	13 / 16 / 19	

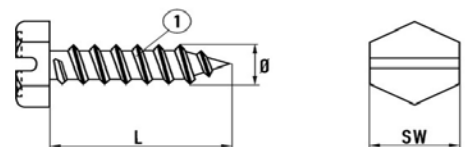

Skrutka samovrtná		
Kvalita	DIN 7504	
	Nerez C1 +GZ (AISI 410)	Pozink
Variant	Bez podložky	
	Podložka nerez + EPDM	
Priemer	4,2 / 4,8	
Dĺžka	13 / 16 / 19	

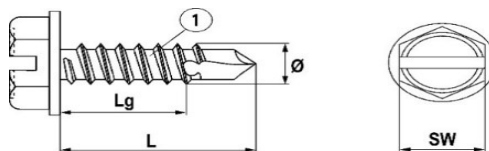

Pracka - patentný uzáver			
Kvalita	Nerez V2A (AISI 304)		
	Pozink		
Variant:	1/60 F	2/55/60 F	4/80 F
Priemer	3,3 / 4,2	3,3 / 4,2	5,00
Šírka, dĺžka	16 x 67	20 x 107	28 x 122

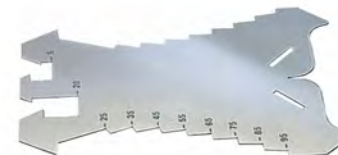

Povrchy: do vonkajšieho prostredia (náhrada oplechovania)

Náhrada klasického oplechovania. Zloženie fólie zaručuje dobrú mechanickú odolnosť proti pretrhnutiu a prerazeniu. Veľmi vysoká odolnosť proti atmosferickým vplyvom a UV žiareniu. Rýchla a čistá aplikácia.



Samolepiaca povrchová úprava do vonkajšieho prostredia (fólia kovovej farby)

Položka	Popis	MJ	EUR/MJ bez DPH	EUR/bal. bez DPH
Anticor CLAD 155 0,6 x 50m	samolepiaci, kovovo hladký UV odolný laminovaný AL povrch	m2	10,30 €	309 €
Anticor CLAD 155 páska 50mm x 50m	samolepiaci, kovovo hladký UV odolný laminovaný AL povrch	ks	29,00 €	-
Anticor CLAD 155 páska 75mm x 50m	samolepiaci, kovovo hladký UV odolný laminovaný AL povrch	ks	43,50 €	-
Anticor CLAD 155 páska 100mm x 50m	samolepiaci, kovovo hladký UV odolný laminovaný AL povrch	ks	58,00 €	-
Anticor CLAD 155 0,6 x 50m	samolepiaci, kovovo štrukturovaný UV odolný laminovaný AL povrch	m2	13,10 €	393 €
Anticor CLAD 155 páska 50mmx 50m	samolepiaci, kovovo štrukturovaný UV odolný laminovaný AL povrch	ks	29,40 €	-



Samolepiaca povrchová úprava do vonkajšieho prostredia (fólia kovovej farby)

Položka	Popis	MJ	EUR/MJ bez DPH	EUR/bal. bez DPH
Tembutil IF (hr.1,0 mm) 1 x 15m	kovovo matný UV odolný povrch + samolepiaca butylová parozábrana	m2	17,50 €	263 €

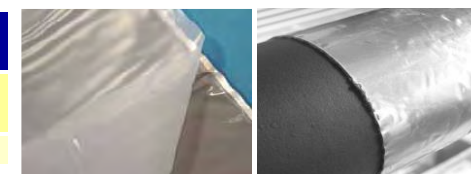

Povrchová úprava do vonkajšieho prostredia (fólia kovovej farby na drôtenom pletive)

Položka	Popis	MJ	EUR/MJ bez DPH	EUR/bal. bez DPH
FLEXIPANE kamenná 1 x 50m	fólia kovovo lesklej farby na pomedenom štvorhrannom pletive- oko:12mm	m2	6,00 €	300 €
FLEXIPANE 16 1 x 50m	fólia kovovo lesklej farby na šesťhrannom pozinkovanom pletive- oko:16mm	m2	7,00 €	175 €
FLEXIPANE 25 1 x 50m	fólia kovovo lesklej farby na šesťhrannom pozinkovanom pletive- oko:25mm	m2	6,00 €	150 €



ARMACELL príslušenstvo

Položka:	Popis:	Rozmery:	ks/ bal.	EUR/ks bez DPH
Lepidlo Ultima 700 1l	Adhesive Ultima AHU-700/1,0	1,0 l	12	51,75 €
Lepidlo Ultima RS 850 0,8l	Adhesive Ultima AHU-RS 850/0,7l	0,8 l	6	78,65 €
Lepidlo Ultima SF990 0,8l	Adhesive Ultima AHU-SF990/0,8	0,8 l	12	95,75 €
Ultima páska 50	UD-TAPE	15m - 50x3mm	12	160,45 €
Lepidlo Armaflex 520 0,25l so štetcom	Adhesive Armaflex ADH-520/0,25E	0,25 l	24	17,45 €
Lepidlo Armaflex 520 0,5l	Adhesive Armaflex ADH-520/0,5E (420g)	0,5 l	12	14,35 €
Lepidlo Armaflex 520 1l	Adhesive Armaflex ADH-520/1,0E (840g)	1,0 l	12	31,90 €
Lepidlo Armaflex 520 2,5l	Adhesive Armaflex ADH-520/2,5E(2100g)	2,5 l	8	67,65 €
Armaflex AF páska 50	AF-TAPE B1	50x3mm x 15m	12	62,00 €
Armaflex AC páska 50	AC-TAPE/50	50x3mm x 15m	12	28,50 €
Armaflex NH páska 50	NH-TAPE	50x3mm x 15m	12	86,95 €
Čistič na lepidlo Armaflex 520 a 625 1l	Cleaner for adhesive 520/625 CLEANER/1,0	1,0 l	4	20,25 €
Lepidlo HT/Armaflex 625 0,25l	Adhesive Armaflex ADH-HT625/0,25	0,25 l	40	28,15 €
Lepidlo HT/Armaflex 625 0,5l	Adhesive Armaflex ADH-HT625/0,5 (420g)	0,5 l	12	31,55 €
Lepidlo HT/Armaflex 625 1l	Adhesive Armaflex ADH-HT625/1,0 (840g)	1,0 l	12	49,05 €
Armaflex HT páska 50	HT-TAPE	50x3mm x 15m	12	63,70 €
Armaflex HT S páska PE biela	Tape FE 902	50x0,08mm x 25m	30	40,90 €
Armaflex HT S páska PE čierna	Tape FE 904	50x0,08mm x 25m	30	51,20 €
Armacomfort páska PE čierna	Tape FE 904	50x0,08mm x 25m	30	51,20 €
Arma-Chek SILVER páska 30	ACH-PSATAPES-30	30mm x 50m	1	30,10 €
Arma-Chek SILVER páska 50	ACH-PSATAPES-50	50mm x 50m	1	72,40 €
Farba Armafinish (biela farba RAL 9001) 2,5l	Armafinish 99 cream white FINISH/WH-2,5 (3kg)	2,5 l	4	136,70 €
Farba Armafinish (šedá farba RAL 7037) 2,5l	Armafinish 99 silver grey FINISH/GY-2,5 (3kg)	2,5 l	4	136,70 €
Štetec s mechanickým dávkovačom	Glumaster (pump) 0,25 Litre	1 ks	-	82,75 €
Náhradný štetec 11 mm	Glumaster-Brush 11 mm	1 ks	-	23,00 €
Náhradný štetec 17 mm	Glumaster-Brush 17 mm	1 ks	-	20,15 €
Tubolit páska TL 50 (šedá)	TL-TAPE/50-DG	50x3mm x 10m	12	14,65 €
Tubolit páska AR 50 (modrá)	TL-TAPE/50-AR	50x3mm x 15m	12	27,65 €
Tubolit páska AR FONOWAVE 50 (modrá)	TL-TAPE/50-ARW	50x3mm x 15m	12	31,65 €
Spony na Tubolit	TL-CLIPS	1 ks	100	0,02 €



KAIMANN príslušenstvo

Položka:	Popis:	Rozmery:	ks/ bal.	EUR/ks bez DPH
Kaiflex 414 lepidlo 0,26l so štetcom	Kaiflex 414 adhesive 0,26l (220g)	0,26 l	24	10,75 €
Kaiflex 414 lepidlo 0,79l	Kaiflex 414 adhesive 0,79l (660g)	0,79 l	20	19,75 €
Kaiflex 414 lepidlo 2,6l	Kaiflex 414 adhesive 2,6l (2200g)	2,6 l	6	52,35 €
Kaiflex 515 ECO		1 kg	6	60,60 €
ST páska 50	ST tape - self adhesive	15m - 50x3mm	12	16,10 €
ST páska 100	ST tape - self adhesive	15m - 100x3mm	6	37,60 €
EF páska 50	EF tape - self adhesive	15m - 50x3mm	12	14,50 €
Kaiflex - špec. čistiadlo 1l	Special cleaner	1l	12	15,75 €
EPDM lepidlo 0,79l	Solar EPDM adhesive	660g	20	37,60 €
EPDM páska 50	Solar EPDM tape -self adhesive	15m - 50x3mm	12	48,60 €
ALU TEC butyl páska 50	ALU TEC butyl tape	25m -50mm	12	79,55 €
ALU TEC páska 50	ALU TEC tape	50m - 50mm	24	52,35 €
ALU TEC samolepiaci povlak	ALU TEC pre covered	25m -1000mm	1	35,30 €
Kaiflex - Finish (biela farba)	Kaifinish protective coating pure white RAL 9010	0,75l	12	39,35 €
Štetec s mechanickým dávkovačom - krátka	Adhesive pump +17mm paintbrush	1 ks	-	78,10 €
Štetec s mechanickým dávkovačom - dlhá	Adhesive pump +17mm paintbrush	1 ks	-	66,40 €
Náhradný štetec 11 mm	Paintbrush 11 mm	1 ks	-	19,70 €
Náhradný štetec 17 mm	Paintbrush 17 mm	1 ks	-	21,25 €
Sada nožov	kaiflex set of knives (3 knives, 1 grinding stone)	1 ks	-	30,90 €
Nôž pre rezanie pásov	Knife	1 ks	-	30,15 €

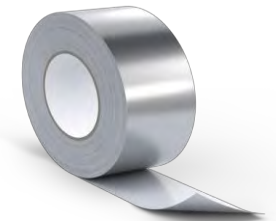

AZ FLEX príslušenstvo

Položka:	Popis:	ks/ bal.	EUR/ks bez DPH
Rezacia šablóna - malá	Vnútorne rozmery (d x š x v) 400 x 105 x 110mm	1	52,20 €
Rezacia šablóna - veľká	Vnútorne rozmery (d x š x v) 680 x 200 x 210mm	1	75,30 €
Rezacia šablóna - rozoberateľná	Vonkajšie rozmery (d x š x v) 430 x 450 x 350mm	1	75,00 €
Nôž dlhý rovný	Ostrie noža s dĺžkou 250 až 350 mm	1	14,00 €
Nôž dlhý zubatý	Ostrie noža s dĺžkou 300 mm	1	14,00 €
Nožnice na rohože s pletivom	Ostrie noža s dĺžkou 250mm	1	104,00 €
Viazací drôt 0,6mm	Pozinkovaný drôt 0,65mm x 30m - 0,1kg	25	1,00 €
Háčik na rohože s pletivom 95mm	Blanket hooks, steel zinc plated, diameter 2 mm, length 95 mm	1000	0,025 €
Háčik na rohože s pletivom 115mm	Blanket hooks, steel zinc plated, diameter 2 mm, length 115 mm	1000	0,030 €
Stabil páska 10m x 40mm	Samolepiaca páska červenej, modrej alebo bielej farby	1	7,00 €
Lepidlo Mirelon-Therm 0,1l	Tuba 100ml	1	4,00 €
Lepidlo Mirelon-Therm 0,5l	Plechovka 500 ml	1	8,00 €
Izoflex P2 4/25 PE páska 40mm x 25m	25m - 2x40mm	1	8,00 €
Izoflex P2 4/25 PE páska 40mm x 10m	10m - 2x40mm	1	4,00 €
Kaiflex/Armaflex páska 48mm x 15m	15m - 3x48mm	1	10,80 €
Kaiflex/Armaflex páska 98mm x 15m	15m - 3x98mm	1	21,60 €
Power Spray lepidlo 500ml	Aerosolové lepidlo na lepenie vláknitých izolácií, spotreba cca 5m2	1	8,00 €



Navarovacie trne Ø 2,7mm s klobučíkom Ø 30mm

Položka:	Třne na priváranie kondenzátorovým výbojom tzv. hrotovým zapáľovaním pre izoláciu s AL polepom hr. (mm):	Variant DE	Variant CZ	ks/bal.	EUR/ks bez DPH
Navarovací trň - izolovaný 19mm	20	x	x	500	0,12 €
Navarovací trň - izolovaný 25,4mm	25	x	x	500	0,13 €
Navarovací trň - izolovaný 28mm	30	x	x	500	0,13 €
Navarovací trň - izolovaný 31,7mm	30	x	x	500	0,14 €
Navarovací trň - izolovaný 38mm	40	x	x	500	0,14 €
Navarovací trň - izolovaný 47,6mm	50	x	x	500	0,15 €
Navarovací trň - izolovaný 54mm	60	x	x	500	0,17 €
Navarovací trň - izolovaný 57,2mm (58mm)	60	x	x	500	0,17 €
Navarovací trň - izolovaný 60,5mm	60	x	x	500	0,17 €
Navarovací trň - izolovaný 63,5mm (64mm)	60	x	x	500	0,18 €
Navarovací trň - izolovaný 76mm	80	x	x	500	0,19 €
Navarovací trň - izolovaný 78mm	80	x	x	500	0,19 €
Navarovací trň - izolovaný 98mm	100	x	x	500	0,20 €
Navarovací trň - izolovaný 139mm	140		x	500	0,37 €
Navarovací trň - izolovaný 152,4mm	150		x	500	0,37 €



Navarovacie trne

Položka:	Popis:	ks/ bal.	EUR/ks bez DPH
Samosvorná podložka Ø 30mm	Pre trne Ø 2mm	1000	0,04 €
Samosvorná podložka Ø 38mm	Pre trne Ø 2mm	1000	0,05 €
Samosvorná podložka nerez Ø 30mm	Pre trne Ø 2mm	1000	0,20 €
Samosvorná podložka nerez Ø 38mm	Pre trne Ø 2mm	1000	0,24 €
Navarovací trň Ø 2mm x 105mm	Oceľový trň (pomednený) na priváranie kondenzátorovým výbojom.	1000	0,05 €



Navarovacie agregáty

Položka:	Popis:	ks/ bal.	EUR/ks bez DPH
Navarovací agregát LBS 075	66 000 µF, Ø 2-8mm, až 20ks/min., rozmery 195x265x410, 11kg	ks	3 250 €
Navarovací agregát LBS 044	44.000 µF, Ø 2-6mm, až 20ks/min., rozmery 195x260x400, 10kg	ks	2 950 €
Navarovací agregát ISOFIX	88.000 µF, Ø 2-3mm, až 30ks/min., rozmery 195x320x270, 7kg	ks	2 500 €
Navarovací agregát ISOFIX accu	88.000 µF, Ø 2-3mm, až 20ks/min., rozmery 195x202x270, 9kg	ks	3 200 €
Magnetická klieština kompl.	Magnet + plastový kryt	ks	148 €
Náhradný magnet	Magnet	ks	90 €
Prenájom navarovacieho agregátu	1 deň, rozmery 195x260x400, 10kg	deň	35 €



Samolepiace AL pásy

Položka:	hr.AL / hr. celkom	Popis:	EUR/bm bez DPH	EUR/ks bez DPH
Páska ALU 302 48mm x 50m x (24)	0,03 / 0,06	Preložka zo silikónového papiera, akrylátové lepidlo, pevnosť v ťahu 45N/25mm, lepiivosť k oceli 15N/25mm.	0,120 €	6,00 €
Páska ALU 302 75mm x 50m x (16)			0,200 €	10,00 €
Páska ALU 302 100mm x 50m x (12)			0,260 €	13,00 €
Páska ALU 301/1C 50mm x 100m (24)	0,03 / 0,06	Preložka z PE fólie, akrylátové lepidlo, pevnosť v ťahu 45N/25mm, lepiivosť k oceli 15N/25mm. Opačné radenie vrstiev	0,144 €	14,40 €
Páska ALU 301/1C 75mm x 100m (16)			0,216 €	21,60 €
Páska ALU 301/1C 100mm x 100m (12)			0,288 €	28,80 €
Páska ALU 352-353 + mriežka 48mm x 50m (24)	0,043 / 0,083	Preložka zo silikónového papiera, akrylátové lepidlo, pevnosť v ťahu 100N/25mm, lepiivosť k oceli 15N/25mm.	0,220 €	11,00 €
Páska ALU 352-353 + mriežka 75mm x 50m (16)			0,330 €	16,50 €
Páska ALU 352-353 + mriežka 100mm x 50m (12)			0,440 €	22,00 €
Páska ALU 306 BLACK 50mm x 50m (24)	0,03 / 0,07	Preložka zo silikónového papiera, akrylátové lepidlo,	0,280 €	14,00 €
Páska ALU 306 BLACK 75mm x 50m (16)			0,420 €	21,00 €
Páska ALU 306 BLACK 100mm x 50m (12)			0,560 €	28,00 €

Samolepiace BOPP / PE pásy

Položka:		Popis:	EUR/bm bez DPH	EUR/ks bez DPH
Páska BOPP 341 pokovená 50m x 50mm (96)	- / 0,03	Pevnosť v ťahu 120N/25mm, lepiivosť 5N/25mm	0,066 €	3,30 €
Páska PVC 111 Polytex šedá + textilná mriežka 25mm x 38mm (40)		Pevnosť v ťahu 90N/25mm, lepiivosť 20N/25mm	0,148 €	3,70 €

Výstražné pásy / fólie

Položka:		Popis:	EUR/bm bez DPH	EUR/ks bez DPH
Fólia červeno/biela		výstražná fólia 100m x 80mm	0,040 €	4,00 €
Fólia žltá- potlač POZOR PLYN		výstražná fólia 100m x 300mm	0,150 €	15,00 €
Fólia biela - potlač POZOR VODA		výstražná fólia 100m x 300mm	0,135 €	13,50 €
Fólia modrá - potlač POZOR VODA		výstražná fólia 100m x 300mm	0,135 €	13,50 €
Fólia modrá		výstražná fólia 100m x 300mm	0,135 €	13,50 €
Fólia oranžová		výstražná fólia 100m x 300mm	0,135 €	13,50 €
Fólia zelená		výstražná fólia 100m x 300mm	0,135 €	13,50 €
Fólia hnedá		výstražná fólia 100m x 300mm	0,135 €	13,50 €



Samolepiace AL pásy

Položka:	hr.AL / hr. celkom	Popis:	EUR/bm bez DPH	EUR/ks bez DPH
Páska ALU 930 SE Coroplast 50mm x 100m (24)	0,025 / 0,05	Opačné radenie vrstiev, preložka z PP fólie, syntetické lepidlo, pevnosť v ťahu 20N/cm, lepidivosť 10N/cm	0,120 €	12,00 €
Páska ALU 930 SE Coroplast 75mm x 100m (16)	0,025 / 0,05		0,180 €	18,00 €
Páska ALU 930 SE Coroplast 100mm x 100m x 0,05mm (12)	0,025 / 0,05		0,240 €	24,00 €
Páska ALU 1530 AWX Coroplast 50mm x 100m (24)	0,025 / 0,05	Opačné radenie vrstiev, preložka z PP fólie, akrylátové lepidlo, pevnosť v ťahu 20N/cm, lepidivosť 8N/cm	0,140 €	14,00 €
Páska ALU 1530 AWX Coroplast 75mm x 100m (16)	0,025 / 0,05		0,210 €	21,00 €
Páska ALU 1530 AWX Coroplast 100mm x 100m (24)	0,025 / 0,05		0,280 €	28,00 €
Páska ALU 912 s mriežkou Coroplast 50mm x 50m (24)	- / 0,13	Preložka z PP fólie, syntetické lepidlo, pevnosť v ťahu 30N/cm, lepidivosť 6N/cm	0,200 €	10,00 €
Páska ALU 912 s mriežkou Coroplast 75mm x 50m (16)	- / 0,13		0,300 €	15,00 €
Páska ALU 912 AWX s mriežkou Coroplast 100mm x 50m (12)	- / 0,13		0,480 €	24,00 €
Páska Coroplast 1233 X SILVER 100mm x 50m (12)	0,08 (2 vrst.)	UV odolná páska, akryl. lep., preložka z papieru, pevnosť 40N/cm, lepidivosť 8N/cm	1,000 €	50,00 €
Páska Coroplast 1232 X SILVER 100mm x 50m (12)	0,12 (4 vrst.)	UV odolná páska, akryl. lep., preložka z papieru, pevnosť 65N/cm, lepidivosť 12N/cm	1,200 €	60,00 €



Samolepiace AL pásy

Položka:	hr.AL / hr. celkom	Popis:	EUR/bm bez DPH	EUR/ks bez DPH
Páska ALU P01G 50mm x 50m (24)	0,03 / 0,07	Preložka zo silikón. papiera, akrylátové lep., pevnosť v ťahu 20N/2,5cm, lepidivosť 15N/2,5cm	0,150 €	7,50 €
Páska ALU P01G 75mm x 50m (16)			0,220 €	11,00 €
Páska ALU P01G 100mm x 50m (12)			0,280 €	14,00 €
Páska ALU P01F 50mm x 100m (24)	0,025 / 0,065	Opačné radenie vrstiev, preložka z PE fólie, polyakrylátové lepidlo, pevnosť v ťahu 30N/2,5cm, lepidivosť 15N/2,5cm	0,155 €	15,50 €
Páska ALU P01F 75mm x 100m (16)			0,235 €	23,50 €
Páska ALU P01F 100mm x 100m (12)			0,310 €	31,00 €



Samolepiace BOPP/PE pásy

Položka:		Popis:	EUR/bm bez DPH	EUR/ks bez DPH
Páska BOPP P02 pokovená 50mm x 50m (36)	- / 0,05	Pevnosť v ťahu 100N/25mm, lepidivosť 5N/25mm	0,052 €	2,60 €
Páska PVC P16 šedá 38mm x 33m (60)	- / 0,13	Akrylátové lepidlo, pevnosť v ťahu 25N/25mm, lepidivosť 1,5N/25mm.	0,106 €	3,50 €
Páska PVC P16 šedá 50mm x 33m (48)			0,136 €	4,50 €

Samolepiace AL butylové pásy

Položka:		Popis:	EUR/bm bez DPH	EUR/ks bez DPH
Páska ALU S06 butylová 50mm x 10m (12)	- / 1	Páska s adhéznym butylkaučukovým lep., pevnosť v ťahu 60N/25mm.	1,500 €	15,00 €
Páska ALU S06 butylová 100mm x 10m (6)			2,900 €	29,00 €



PASÍVNE PROTIPOŽIARNE RIEŠENIA

ArmaProtect

Naše produkty zahŕňajú certifikované systémy na utesnenie prestupov horľavých, nehorľavých a rôznych servisných potrubí.

 **armacell**[®]
ArmaProtect[™]



ARMAPROTECT

Popis	Kód	Položka	EUR/ks bez DPH	Valenie	
Firestopping Coating	PRO-ABLC-12.5kg	ARMAPROTECT ABLC Firestop Coating 12.5 kg white	192,40 €	12,5 kg / pail	
Firestopping filler	PRO-ABLF-12.5kg	ARMAPROTECT ABLF Firestop Filler Mastic 12.5 kg white	192,40 €	12,5 kg / pail	
	PRO-ABLF-310ml	ARMAPROTECT ABLF Firestop Filler Mastic 310 ml white	13,50 €	310 ml / cartridge, 12 cartridges per export box	
Mineral wool board	PRO-CB-60S1	ARMAPROTECT CB Coated Firestop Board 1000x600x60 S1	51,30 €	4 boards per box (0.7 mm dry film thickness) white	
Firetopping mortar	PRO-CM-20kg	ARMAPROTECT CM Firestop Mortar 20 kg grey	46,50 €	20 kg / bag	
Firestoppping filler	PRO-EXPS-310ml-gy	ARMAPROTECT EXPS Firestop Sealant 310 ml grey	12,30 €	310 ml / cartridge, 12 cartridges per export box	
Firestopping Wrap	PRO-FW1-10m	ARMAPROTECT FW1 Firestop Wrap 10 m	269,70 €	10 m / roll	
	PRO-FW2-10m	ARMAPROTECT FW2 Firestop Wrap 10 m	212,80 €	10 m / roll	
	PRO-FW3-12.5m	ARMAPROTECT FW3 Firestop Wrap 12.5 m	298,90 €	12,5 m / roll	
Endless collar	PRO-EFC1-3m	ARMAPROTECT EFC1 Endless Firestop Collar 3 m	221,90 €	10m firestop wrap and 3mstainless steel strap / pcs.	
	PRO-EFC2-3m	ARMAPROTECT EFC2 Endless Firestop Collar 3 m	269,00 €	10m firestop wrap and 3mstainless steel strap / pcs.	
Firestopping Collar	PRO-FC1-050	ARMAPROTECT FC1 Firestop Collar Æ 50 mm	18,70 €	1 firestop collar, 50 firestop collars / export box	
	PRO-FC1-063	ARMAPROTECT FC1 Firestop Collar Æ 63 mm	19,10 €	1 firestop collar, 50 firestop collars / export box	
	PRO-FC1-075	ARMAPROTECT FC1 Firestop Collar Æ 75 mm	20,50 €	1 firestop collar, 50 firestop collars / export box	
	PRO-FC1-090	ARMAPROTECT FC1 Firestop Collar Æ 90 mm	22,40 €	1 firestop collar, 40 firestop collars / export box	
	PRO-FC1-110	ARMAPROTECT FC1 Firestop Collar Æ 110 mm	28,60 €	1 firestop collar, 25 firestop collars / export box	
	PRO-FC1-125	ARMAPROTECT FC1 Firestop Collar Æ 125 mm	36,60 €	1 firestop collar, 20 firestop collars / export box	
	PRO-FC1-140	ARMAPROTECT FC1 Firestop Collar Æ 140 mm	42,20 €	1 firestop collar, 16 firestop collars / export box	
	PRO-FC1-160	ARMAPROTECT FC1 Firestop Collar Æ 160 mm	52,40 €	1 collar, firestop 12 firestop collars / export box	
	PRO-FC2-032	ARMAPROTECT FC2 Firestop Collar Æ 32 mm	26,30 €	1 firestop collar, 50 firestop collars / export box	
	PRO-FC2-040	ARMAPROTECT FC2 Firestop Collar Æ 40 mm	26,50 €	1 firestop collar, 50 firestop collars / export box	
	PRO-FC2-050	ARMAPROTECT FC2 Firestop Collar Æ 50 mm	26,90 €	1 firestop collar, 50 firestop collars / export box	
	PRO-FC2-063	ARMAPROTECT FC2 Firestop Collar Æ 63 mm	27,70 €	1 firestop collar, 50 firestop collars / export box	
	PRO-FC2-075	ARMAPROTECT FC2 Firestop Collar Æ 75 mm	29,60 €	1 firestop collar, 50 firestop collars / export box	
	PRO-FC2-090	ARMAPROTECT FC2 Firestop Collar Æ 90 mm	33,10 €	1 firestop collar, 40 firestop collars / export box	
	PRO-FC2-110	ARMAPROTECT FC2 Firestop Collar Æ 110 mm	36,30 €	1 firestop collar, 25 firestop collars / export box	
	PRO-FC2-125	ARMAPROTECT FC2 Firestop Collar Æ 125 mm	55,90 €	1 firestop collar, 20 firestop collars / export box	
	PRO-FC2-140	ARMAPROTECT FC2 Firestop Collar Æ 140 mm	63,80 €	1 firestop collar, 16 firestop collars / export box	
	PRO-FC2-160	ARMAPROTECT FC2 Firestop Collar Æ 160 mm	79,80 €	1 collar, firestop 12 firestop collars / export box	
	PRO-FC2-180	ARMAPROTECT FC2 Firestop Collar Æ 180 mm	139,50 €	1 firestop collar, firestop 5 collars / export box	
	PRO-FC2-200	ARMAPROTECT FC2 Firestop Collar Æ 200 mm	172,40 €	1 firestop collar, firestop 5 collars / export box	
	PRO-FC2-225	ARMAPROTECT FC2 Firestop Collar Æ 225 mm	310,00 €	1 firestop collar	
	PRO-FC2-250	ARMAPROTECT FC2 Firestop Collar Æ 250 mm	325,00 €	1 firestop collar	
	PRO-FC2-280	ARMAPROTECT FC2 Firestop Collar Æ 280 mm	534,50 €	1 firestop collar	
	PRO-FC2-300	ARMAPROTECT FC2 Firestop Collar Æ 300 mm	748,30 €	1 firestop collar	
	PRO-FC2-315	ARMAPROTECT FC2 Firestop Collar Æ 315 mm	791,10 €	1 firestop collar	
	PRO-FC2-355	ARMAPROTECT FC2 Firestop Collar Æ 355 mm	812,50 €	1 firestop collar	
	PRO-FC2-400	ARMAPROTECT FC2 Firestop Collar Æ 400 mm	1 047,70 €	1 firestop collar	
	Cable Tube	PRO-CT-L090	ARMAPROTECT CT Firestop Cable Tube 300 mm / Æ 90 mm	83,00 €	1 cable tube with 2 soft plugs / pcs.
		PRO-CT-L116	ARMAPROTECT CT Firestop Cable Tube 300 mm / Æ 116 mm	98,10 €	1 cable tube with 2 soft plugs / pcs.
		PRO-CT-M090	ARMAPROTECT CT Firestop Cable Tube 200 mm / Æ 90 mm	67,90 €	1 cable tube with 2 soft plugs / pcs.
		PRO-CT-M116	ARMAPROTECT CT Firestop Cable Tube 200 mm / Æ 116 mm	81,80 €	1 cable tube with 2 soft plugs / pcs.
		PRO-CT-C060	ARMAPROTECT CT Firestop Cable Tube Cap Set (10 pcs.) Æ 60 mm	32,60 €	10 soft plugs / set
PRO-CT-C090		ARMAPROTECT CT Firestop Cable Tube Cap Set (10 pcs.) Æ 90 mm	40,70 €	10 soft plugs / set	
PRO-CT-C116		ARMAPROTECT CT Firestop Cable Tube Cap Set (10 pcs.) Æ 116 mm	48,80 €	10 soft plugs / set	
Label	PRO-ID-SET	ARMAPROTECT ID Identification Plate Set (5 pieces)	13,90 €	5 identification plates / set	

Penetračné postreky na likvidáciu AZC materiálov

Položka:	Popis:	ks/ bal.	EUR/ks bez DPH
Foster® 32-60 25 l	Spotreba: 5 až 7,5m ² /liter, riedenie možné až do pomeru 1:4.	1	172 €



Striekaná PUR pena

Položka:	Popis:	MJ	EUR/MJ bez DPH
Froth Pak Foam system 600 SR (A+B)	balenie 2x20kg, 34-40kg/m ³ , výdatnosť 1,1 až 1,3m ³ , expanzia 70s, tepelná vodivosť 0,022 W/(m.K), trieda reakcie na oheň E, použitie pre teploty od -150 do +100°C	1 set	1 400 €







Položka:	Popis:	MJ	EUR/MJ bez DPH
Standart GHA-9	set: pištoľ + hadice 2,9m + sprejovacie trysky 10ks	1 set	120 €
Standart GHA-15	set: pištoľ + hadice 4,6m + sprejovacie trysky 10ks	1 set	150 €
Aplikačná tryska (cone nozzle)	injektážna tryska 25ks/bal (prietok 2kg/min)	bal	50 €
Vazelína v spreji	Vhodné pre aplikačné trysky	ks	10 €
Čistič PUR v spreji	Vhodné na čistenie aplikačnej pištole	ks	10 €
Prenájom - vyhrievacia deka 600mm x 30mm	25W -230V	ks	50 €



Tabuľka rozmerov potrubí a ich vonkajších priemerov

Medené potrubie:		PPR/ PVC potrubie: vonk. Ø (mm)	Oceľové potrubie:			Vonk. Ø potrubia
vnútorný Ø DN (mm)	Coul		vnútorný Ø DN (mm)	Coul	vonk. Ø (mm)	
4	1/4				6	
6					8	
8	3/8		6	1/8	10.2	
10	1/2				12	
12	5/8	14	8	1/4	13.5	
			10	3/8	17.2	
		20			20	
20	7/8		15	1/2	21.3	
		25			25	
25	1 1/8		20	3/4	26.9	
					30	
		32			32	
32	1 3/8	40	25	1	33.7	
		40			40	
40	1 5/8		32	1 1/4	42.4	
					44.5	
		50	40	1 1/2	48.3	
					50	
50	2 1/8				54	
					57	
			50	2,0	60.3	
		63			64	
60					70	
72	2 3/4				76	
	3	75	65	2 1/2	76.1	
	3 1/8				80	
85		90	80	3	88.9	
				3 1/2	101.6	
103	4 1/4	110	100		108,0	
			100	4	114.3	
		125			125	
127			125,0		133,0	
			125	5	139,7	
153			150,0		159,0	
			150,0	6	168,3	
		200			204	
213			200		219.1	
		250			254	
			250		273	
			300,0		324,0	
			350,0		377,0	
			400,0		457,0	

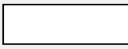
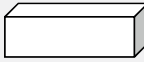
Matematika		
obvod kruhu	$O=2.\pi.r$ alebo $O=\pi.d$	
obsah kruhu	$S=\pi.r^2$	
povrch valca	$S=2.\pi.r.(v+r)$ alebo $S=\pi.d.(v+r)$	
objem valca	$V=\pi.r^2.v$	
obvod štvorca	$O=4.a$	
obsah štvorca	$S=a.a$	
povrch kocky	$S=6.a.a$	
objem kocky	$V=a.a.a$	
obvod obdĺžnika	$O=2.a+2.b$	
obsah obdĺžnika	$S=a.b$	
povrch kvádra	$S=2.(a.b+a.c+b.c)$	
objem kvádra	$V=a.b.c$	

Výpočet dĺžky lamelovej rohože pre potrubie (napr. VZT):

Kruhové potrubie	$L=(d+2.t).\pi$
Pravouhlé potrubie	$L=2.a+2.b+8.t$

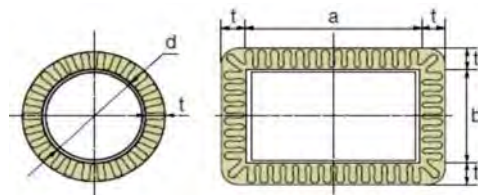

Tabuľky spotreby pre izolácie zo syntetického kaučuku (Armaflex, Kaiflex a pod.)
Spotreba lepidla (trubicová izolácia)

Hrúbka izolácie (mm):	10	20	30	40
Pozdĺžne nerozrezaná trubicová izolácia	1120 m/l	280 m/l	175 m/l	130 m/l
Pozdĺžne rozrezaná trubicová izolácia	140 m/l	70 m/l	45 m/l	35 m/l

Spotreba lepidla (plošná izolácia):

Hrúbka izolácie (mm):	10	20	30	40
Doskový materiál (pásky)		3 - 4 m ² z 1 litra		

Množstvo m2 plošnej izolácie potrebnej k zaizolovaniu armatúry (hr. izol 9 až 32mm)

Priemer potrubia (mm):	90° ohyb	45° ohyb	T-Kus	Ventil	Rovný kus:	Príruba
89	0,15	0,13	0,09	0,40	0,44	0,21
114	0,21	0,18	0,10	0,51	0,52	0,29
140	0,29	0,24	0,12	0,72	0,60	0,35
169	0,38	0,32	0,14	0,93	0,69	0,40
219	0,57	0,47	0,21	1,10	0,84	0,55
273	0,83	0,69	0,26	1,40	1,02	0,79
324	1,11	0,93	0,40	1,80	1,18	0,97
356	1,30	1,09	0,43	2,31	1,28	1,17
406	1,65	1,38	0,48	2,90	1,43	1,42
457	2,05	1,71	0,54	3,60	1,60	1,70
508	2,46	2,05	0,59	4,40	1,75	2,05

Pracovný čas (v minútach), potrebný na narezanie a zalepenie izolácie (normovaná spotreba pri montáži do výšky 2m)

Priemer potrubia (mm):	90° ohyb	45° ohyb	T-Kus	Ventil	Rovný kus (1m)	Príruba	Kryt tvaru D	Redukcia
12	3	3	3	5	6	10		3
25	3	3	3	5	6	10		3
32	3	3	3	5	6	10		3
40	3	3	3	5	6	10		3
50	4	4	4	15	6	10	10	5
65	4	5	5	20	6	15	15	6
80	8	4	4	20	8	15	15	46
100	10	5	5	30	9	20	20	10
150	15	8	8	40	12	25	30	15
200	20	10	10	50	15	30	40	20

čas vypočítaný pre plošnú izoláciu.

Izolačné pásy a ich použitie na potrubiach

Priemer potrubia (mm):	Hrúbka izolácie (mm):					
	9	13	19	25	32	50
od Ø 89	áno	áno				
od Ø 114	áno	áno	áno			
od Ø 160	áno	áno	áno	áno		
od Ø 250	áno	áno	áno	áno	áno	áno
od Ø 600	áno	áno	áno	áno	áno	áno

Počet kusov armatúr, ktoré je možné urobiť z 1 metra potrubnej izolácie

Priemer potrubia (mm):	90° ohyb	45° ohyb	2+1 segment. koleno	2+2 segment. koleno	T-Kus	Redukcia
15	5	7	5	4	10	10
22	5	7	5	4	10	10
28	5	7	5	4	10	10
35	5	7	5	4	10	10
42	5	6	5	4	10	10
48	5	6	5	4	7	7
60	4	6	4	3	7	7
76	4	6	4	3	5	5
89	4	5	4	3	5	5
114	3	5	3	2	5	5

Spotreba ochrannej farby Armafinish alebo Kaifinish (v litroch), počítaná pri dvoch vrstvách náteru (cca 4 m²/1 liter)

Vonkajší priemer na izolácii (mm):	Dĺžka potrubia (m)			
	1	10	50	100
60	0,1	1,0	5,2	10,4
80	0,1	1,4	6,9	13,8
100	0,2	1,7	8,6	17,3
120	0,2	2,1	10,4	20,7
140	0,2	2,4	12,1	24,2
160	0,3	2,8	13,8	27,6
180	0,3	3,1	15,5	31,1
200	0,3	3,5	17,3	34,5
225	0,4	3,9	19,4	38,9
250	0,4	4,3	21,6	43,2
300	0,5	5,2	25,9	51,8
400	0,7	6,9	34,5	69,1

Priemerná spotreba množstva (metrov) pásky, počítaná pri prelepovaní všetkých lepených spojov (pričných aj pozdĺžnych) 1 metra izolácie hrúbky 13, 19 a 25 mm

Priemer potrubia (mm):	Rozrezaná izolácia (1m)			Nerozrezaná izolácia (1m) alebo T-Kus (1ks)			90°koleno 2+1 segment (1ks)			90°koleno 2+2 segmenty (1ks)			90°koleno 2+3 segmenty (1ks)		
	13	19	25	13	19	25	13	19	25	13	19	25	13	19	25
10	1,24	1,28	1,32	0,14	0,18	0,22	0,25	0,34	0,41	0,38	0,50	0,60	0,50	0,67	0,81
12	1,25	1,29	1,32	0,15	0,19	0,22	0,27	0,35	0,42	0,40	0,52	0,62	0,53	0,70	0,84
15	1,26	1,30	1,33	0,16	0,20	0,23	0,29	0,37	0,44	0,43	0,55	0,66	0,57	0,76	0,91
20	1,27	1,31	1,35	0,17	0,21	0,25	0,32	0,40	0,47	0,48	0,61	0,72	0,64	0,80	0,94
22	1,28	1,32	1,36	0,18	0,22	0,26	0,34	0,42	0,49	0,50	0,63	0,74	0,67	0,84	0,98
28	1,30	1,34	1,38	0,20	0,24	0,28	0,38	0,46	0,53	0,56	0,69	0,80	0,75	0,92	1,07
35	1,32	1,36	1,40	0,22	0,26	0,30	0,43	0,51	0,58	0,64	0,76	0,87	0,85	1,04	1,19
42	1,34	1,38	1,42	0,24	0,28	0,32	0,47	0,56	0,64	0,71	0,83	0,94	0,94	1,12	1,27
48	1,36	1,40	1,44	0,26	0,30	0,34	0,52	0,60	0,68	0,77	0,90	1,01	1,03	1,20	1,35
60	1,40	1,44	1,48	0,30	0,34	0,38	0,60	0,68	0,76	0,90	1,02	1,13	1,19	1,36	1,51
76	1,45	1,49	1,53	0,35	0,39	0,43	0,70	0,78	0,85	1,03	1,14	1,25	1,40	1,55	1,70
89	1,49	1,53	1,57	0,39	0,43	0,47	0,78	0,86	0,93	1,15	1,26	1,37	1,57	1,72	1,87
114	1,57	1,61	1,65	0,47	0,51	0,55	0,94	1,02	1,09	1,38	1,49	1,60	1,88	2,03	2,18
133	1,63	1,67	1,70	0,53	0,57	0,60	1,06	1,13	1,21	1,56	1,67	1,78	2,12	2,27	2,42
159	1,71	1,75	1,79	0,61	0,65	0,69	1,22	1,30	1,37	1,80	1,91	2,02	2,44	2,60	2,75
219	1,90	1,94	1,98	0,80	0,84	0,88	1,60	1,67	1,75	2,35	2,46	2,57	3,20	3,35	3,50

Priemerná spotreba množstva (metrov) pásky pri prelepovaní priečneho spoja izolácie

Priemer potrubia (mm):	Hrúbka izolácie (mm):							
	20	25	30	40	50	60	80	100
76	0,39	0,43	0,46	0,51	0,57	0,63	0,73	0,85
89	0,43	0,47	0,50	0,56	0,61	0,68	0,77	0,90
114	0,51	0,55	0,58	0,63	0,69	0,75	0,85	0,97
133	0,57	0,61	0,64	0,69	0,75	0,81	0,91	1,03
160	0,66	0,69	0,73	0,78	0,84	0,90	0,99	1,12
219	0,84	0,88	0,91	0,96	1,02	1,08	1,18	1,30

Spotreba spôn pri polyetylénových potrubných izoláciách

Spony (céčka) **cca 5 ks na 1bm**

Spotreba navarovacích trňov

Navarovací trň **11-20 ks na 1m²**

Počet m² v m³

Množstvo (m2) izolácie v objeme:	Hrúbka plošnej izolácie:														
	9	13	20	25	30	40	50	60	70	80	90	100	120	140	200
m2 v 1 m3	111	76,9	50,0	40,0	33,3	25,0	20,0	16,7	14,3	12,5	11,1	10,0	8,3	7,1	5,0
m2 v 5 m3	556	385	250	200	167	125	100	83,3	71,4	62,5	55,6	50,0	41,7	35,7	25,0
m2 v 15 m3	1667	1154	750	600	500	375	300	250	214	188	167	150	125	107	75,0
m2 v 40 m3	4444	3077	2000	1600	1333	1000	800	667	571	500	444	400	333	286	200
m2 v 90 m3	10000	6923	4500	3600	3000	2250	1800	1500	1286	1125	1000	900	750	643	450

Orientačná potreba pásov (m2) potrebných na zaizolovanie 1bm potrubia resp. tabuľka vonkajších obvodov (na izolácií)

Vonkajší \varnothing potr. (mm)	Dĺžka prírezu (obvodu "m") pre hrúbku izolácie (mm):												
	9 mm	13 mm	20 mm	25 mm	30 mm	40 mm	50 mm	60 mm	80 mm	100 mm	101 mm	150 mm	200 mm
12		0,123	0,168	0,201	0,233	0,30	0,36	0,43	0,56	0,69	0,69	1,01	1,33
15		0,133	0,178	0,210	0,243	0,31	0,37	0,44	0,57	0,70	0,70	1,02	1,34
18		0,142	0,188	0,220	0,252	0,32	0,38	0,45	0,58	0,71	0,71	1,03	1,35
20		0,149	0,194	0,226	0,259	0,32	0,39	0,45	0,58	0,71	0,72	1,03	1,36
22	0,129	0,155	0,201	0,233	0,265	0,33	0,39	0,46	0,59	0,72	0,72	1,04	1,36
25	0,139	0,165	0,210	0,243	0,275	0,34	0,40	0,47	0,60	0,73	0,73	1,05	1,37
28	0,149	0,175	0,220	0,252	0,285	0,35	0,41	0,48	0,61	0,74	0,74	1,06	1,38
30	0,155	0,181	0,226	0,259	0,291	0,36	0,42	0,49	0,61	0,74	0,75	1,07	1,39
32	0,162	0,188	0,233	0,265	0,298	0,36	0,43	0,49	0,62	0,75	0,76	1,07	1,40
35	0,171	0,197	0,243	0,275	0,31	0,37	0,44	0,50	0,63	0,76	0,77	1,08	1,41
38	0,181	0,207	0,252	0,285	0,32	0,38	0,45	0,51	0,64	0,77	0,78	1,09	1,42
42	0,194	0,220	0,265	0,298	0,33	0,39	0,46	0,52	0,65	0,78	0,79	1,11	1,43
45	0,204	0,230	0,275	0,31	0,34	0,40	0,47	0,53	0,66	0,79	0,80	1,12	1,44
48	0,213	0,239	0,285	0,32	0,35	0,41	0,48	0,54	0,67	0,80	0,81	1,13	1,45
50	0,220	0,246	0,291	0,32	0,36	0,42	0,49	0,55	0,68	0,81	0,82	1,13	1,46
54	0,233	0,259	0,30	0,34	0,37	0,43	0,50	0,56	0,69	0,82	0,83	1,14	1,47
57	0,243	0,268	0,31	0,35	0,38	0,44	0,51	0,57	0,70	0,83	0,84	1,15	1,48
60	0,252	0,278	0,32	0,36	0,39	0,45	0,52	0,58	0,71	0,84	0,85	1,16	1,49
64	0,265	0,291	0,34	0,37	0,40	0,47	0,53	0,60	0,72	0,85	0,86	1,18	1,50
76	0,30	0,33	0,38	0,41	0,44	0,50	0,57	0,63	0,76	0,89	0,90	1,22	1,54
80	0,32	0,34	0,39	0,42	0,45	0,52	0,58	0,65	0,78	0,91	0,91	1,23	1,55
89	0,35	0,37	0,42	0,45	0,48	0,55	0,61	0,68	0,81	0,93	0,94	1,26	1,58
102	0,39	0,41	0,46	0,49	0,52	0,59	0,65	0,72	0,85	0,98	0,98	1,30	1,62
108	0,41	0,43	0,48	0,51	0,54	0,61	0,67	0,74	0,87	1,00	1,00	1,32	1,64
114	0,43	0,45	0,50	0,53	0,56	0,63	0,69	0,76	0,89	1,02	1,02	1,34	1,66
125	0,46	0,49	0,53	0,57	0,60	0,66	0,73	0,79	0,92	1,05	1,06	1,37	1,70
133	0,49	0,51	0,56	0,59	0,62	0,69	0,75	0,82	0,95	1,08	1,08	1,40	1,72
140	0,51	0,54	0,58	0,61	0,65	0,71	0,78	0,84	0,97	1,10	1,11	1,42	1,75
160	0,58	0,60	0,65	0,68	0,71	0,78	0,84	0,91	1,03	1,16	1,17	1,49	1,81
168	0,60	0,63	0,67	0,71	0,74	0,80	0,87	0,93	1,06	1,19	1,20	1,51	1,84
219	0,77	0,79	0,84	0,87	0,90	0,97	1,03	1,10	1,23	1,36	1,36	1,68	2,00
245	0,85	0,88	0,92	0,95	0,99	1,05	1,12	1,18	1,31	1,44	1,45	1,76	2,09
273	0,94	0,97	1,01	1,04	1,08	1,14	1,21	1,27	1,40	1,53	1,54	1,85	2,18
366	1,21	1,24	1,28	1,31	1,35	1,41	1,47	1,54	1,67	1,80	1,80	2,12	2,45
457	1,54	1,56	1,61	1,64	1,67	1,74	1,80	1,87	2,00	2,12	2,13	2,45	2,77
558	1,86	1,89	1,93	1,97	2,00	2,06	2,13	2,19	2,32	2,45	2,46	2,77	3,10
630	2,10	2,12	2,17	2,20	2,23	2,30	2,36	2,43	2,56	2,68	2,69	3,01	3,33
714	2,37	2,39	2,44	2,47	2,50	2,57	2,63	2,70	2,83	2,96	2,96	3,28	3,60
813	2,69	2,71	2,76	2,79	2,82	2,89	2,95	3,02	3,15	3,28	3,28	3,60	3,92
914	3,01	3,04	3,09	3,12	3,15	3,21	3,28	3,34	3,47	3,60	3,61	3,93	4,25

Pre výpočet dĺžky prírezu PVC fólie alebo iného povrchu je dôležité pripočítať k obvodu na izolácii presah v rozsahu cca 3 až 10cm (v závislosti od typu povrchu)

Príklad: Pre zaizolovanie potrubia \varnothing 114mm s použitím izolácie hr. 50mm (napr. pre pás šírky 1m), sa použije prírez izolácie dlhý 0,69m

Tepelný odpor

Hodnota tepelného odporu ponúka možnosť porovnať energetickú účinnosť izolácie.

Tepelný odpor "R" vyjadruje tepelnoizolačné vlastnosti izolácie. Je závislý od hrúbky izolácie (alebo konštrukcie) a súčiniteľa tepelnej vodivosti (λ), ktorú udáva výrobca.

Súč. tep. vodivosti λ vyjadruje vlastnosť materiálu viesť teplo. Je to hodnota energie "W", ktorá prejde materiálom hrúbky 1 "m" pri rozdielne teplôt medzi povrchmi materiálu 1 "K".

Väčšiu hodnotu "R" dosiahneme zvýšením hrúbky izolácie (konštrukcie) alebo voľbou jednotlivých materiálov s čo najnižšou hodnotou " λ ".

$$R = d / \lambda \quad [m^2 \cdot K \cdot W^{-1}]$$

R - je tepelný odpor ($m^2 K/W$) alebo ($m^2 \cdot K \cdot W^{-1}$)

d - hrúbka materiálu (m)

λ - súčiniteľ tepelnej vodivosti materiálu, udáva ho výrobca ($W \cdot m^{-1} \cdot K^{-1}$) alebo ($W/m \cdot K$)

Hrúbka izolácie (mm):	Hodnoty tepelného odporu R v závislosti od súčiniteľa tepelnej vodivosti																
	0,020	0,025	0,030	0,031	0,032	0,033	0,034	0,035	0,036	0,037	0,038	0,039	0,040	0,041	0,042	0,043	0,044
1	0,05	0,04	0,03	0,03	0,03	0,03	0,03	0,03	0,03	0,03	0,03	0,03	0,03	0,02	0,02	0,02	0,02
2	0,10	0,08	0,07	0,06	0,06	0,06	0,06	0,06	0,06	0,05	0,05	0,05	0,05	0,05	0,05	0,05	0,05
5	0,25	0,20	0,17	0,16	0,16	0,15	0,15	0,14	0,14	0,14	0,13	0,13	0,13	0,12	0,12	0,12	0,11
9	0,45	0,36	0,30	0,29	0,28	0,27	0,26	0,26	0,25	0,24	0,24	0,23	0,23	0,22	0,21	0,21	0,20
13	0,65	0,52	0,43	0,42	0,41	0,39	0,38	0,37	0,36	0,35	0,34	0,33	0,33	0,32	0,31	0,30	0,30
15	0,75	0,60	0,50	0,48	0,47	0,45	0,44	0,43	0,42	0,41	0,39	0,38	0,38	0,37	0,36	0,35	0,34
19	0,95	0,76	0,63	0,61	0,59	0,58	0,56	0,54	0,53	0,51	0,50	0,49	0,48	0,46	0,45	0,44	0,43
20	1,00	0,80	0,67	0,65	0,63	0,61	0,59	0,57	0,56	0,54	0,53	0,51	0,50	0,49	0,48	0,47	0,45
25	1,25	1,00	0,83	0,81	0,78	0,76	0,74	0,71	0,69	0,68	0,66	0,64	0,63	0,61	0,60	0,58	0,57
30	1,50	1,20	1,00	0,97	0,94	0,91	0,88	0,86	0,83	0,81	0,79	0,77	0,75	0,73	0,71	0,70	0,68
32	1,60	1,28	1,07	1,03	1,00	0,97	0,94	0,91	0,89	0,86	0,84	0,82	0,80	0,78	0,76	0,74	0,73
40	2,00	1,60	1,33	1,29	1,25	1,21	1,18	1,14	1,11	1,08	1,05	1,03	1,00	0,98	0,95	0,93	0,91
50	2,50	2,00	1,67	1,61	1,56	1,52	1,47	1,43	1,39	1,35	1,32	1,28	1,25	1,22	1,19	1,16	1,14
60	3,00	2,40	2,00	1,94	1,88	1,82	1,76	1,71	1,67	1,62	1,58	1,54	1,50	1,46	1,43	1,40	1,36
70	3,50	2,80	2,33	2,26	2,19	2,12	2,06	2,00	1,94	1,89	1,84	1,79	1,75	1,71	1,67	1,63	1,59
80	4,00	3,20	2,67	2,58	2,50	2,42	2,35	2,29	2,22	2,16	2,11	2,05	2,00	1,95	1,90	1,86	1,82
90	4,50	3,60	3,00	2,90	2,81	2,73	2,65	2,57	2,50	2,43	2,37	2,31	2,25	2,20	2,14	2,09	2,05
100	5,00	4,00	3,33	3,23	3,13	3,03	2,94	2,86	2,78	2,70	2,63	2,56	2,50	2,44	2,38	2,33	2,27
120	6,00	4,80	4,00	3,87	3,75	3,64	3,53	3,43	3,33	3,24	3,16	3,08	3,00	2,93	2,86	2,79	2,73
140	7,00	5,60	4,67	4,52	4,38	4,24	4,12	4,00	3,89	3,78	3,68	3,59	3,50	3,41	3,33	3,26	3,18
160	8,00	6,40	5,33	5,16	5,00	4,85	4,71	4,57	4,44	4,32	4,21	4,10	4,00	3,90	3,81	3,72	3,64
180	9,00	7,20	6,00	5,81	5,63	5,45	5,29	5,14	5,00	4,86	4,74	4,62	4,50	4,39	4,29	4,19	4,09
200	10,00	8,00	6,67	6,45	6,25	6,06	5,88	5,71	5,56	5,41	5,26	5,13	5,00	4,88	4,76	4,65	4,55
220	11,00	8,80	7,33	7,10	6,88	6,67	6,47	6,29	6,11	5,95	5,79	5,64	5,50	5,37	5,24	5,12	5,00
240	12,00	9,60	8,00	7,74	7,50	7,27	7,06	6,86	6,67	6,49	6,32	6,15	6,00	5,85	5,71	5,58	5,45
300	15,00	12,00	10,00	9,68	9,38	9,09	8,82	8,57	8,33	8,11	7,89	7,69	7,50	7,32	7,14	6,98	6,82

Napr. tepelný odpor izolácie s parametrom $\lambda_{10°C}=0,042$ pri hr.50mm je takmer rovnaký ako pri izolácií s hodnotou $\lambda_{10°C}=0,034$ v hr.40mm t.j. izolácia s lepšími tepelnoizolačnými vlastnosťami v menšej hrúbke môže izolovať rovnako ako tepelnoizolačne "horší" materiál s väčšou hrúbkou.

Čím vyššie číslo má tepelný odpor "R" tým lepšie, nakoľko izoláciu (konštrukciu) prejde menej tepla, a teda tým lepšie izolácia znižuje energetické straty. Je dôležité porovnávať hodnoty lambdy " λ " namerané pri rovnakej teplote. Spravidla sa porovnáva hodnota lambdy λ , ktorá zodpovedá prevádzkovej teplote média.

Návrh hrúbky technických izolácií pre rozvody tepla a teplej vody v budovách:

Technické požiadavky na tepelnú izoláciu rozvodov tepla a teplej vody sa ustanovujú podľa vyhlášky 14/2016 Z.z Ministerstva hospodárstva Slovenskej republiky §1 Minimálna hrúbka tepelnej izolácie rozvodov tepla a teplej vody v budovách pre izolačný materiál s tepelnou vodivosťou **0,035 W · m-1.K-1 pri teplote 0 °C**, na oceľovom potrubí:

P. č	Vnútorý priemer potrubia alebo armatúry	Minimálna hrúbka izolácie
1	do 22 mm	20 mm
2	od 23 mm do 35 mm	30 mm
3	od 36 mm do 100 mm	rovnaká ako vnútorný ø potrubia
4	nad 100 mm	100 mm

Pre rozdeľovače a zberače tepla, v miestach krížovania potrubí, v miestach spájania potrubí a pre potrubia a armatúry inštalované v prestupoch stien a stropov sa môže minimálna hrúbka izolácie znížiť o 50 % vypočítanej hodnoty hrúbky izolácie.

Hrúbky izolácie sú navrhnuté pre oceľové potrubie a izoláciu s lambdou 0,035 W /(m.K), pri použití iného materiálu potrubia a izolácie budú vypočítané iné hrúbky izolácie

Návrh hrúbky technických izolácií pre rozvody teplej vody a vykurovania:

podľa nemeckého štandardu VDI 2055 (vyhláška o úspore energií EnEV)

Potrubie v palcoch (")	DN potrubia (mm)	Vonk. Ø potr. (mm)	Odporúčaná hrúbka izolácie (mm) v závislosti od súčiniteľa tepelnej vodivosti λ		
			0,035 W/(m·k)	0,040 W/(m·k)	0,045 W/(m·k)
3/8	10	17,2	20	26	34
1,2	15	21,3	20	26	33
3/4	20	26,9	20	25	32
1	25	33,7	30	38	48
1 1/4	32	42,2	36	46	57
1 1/2	40	48,3	42	53	66
2	50	60,3	53	67	83
2 1/2	65	76,1	69	87	107
3	80	88,9	81	102	126
4	100	114,3	100	125	154

Klasifikácia stavebných výrobkov a prvkov stavieb reakcie na oheň:

Reakcia na oheň je schopnosť výrobku za určitých podmienok prispievať vlastným rozkladom k ohňu, ktorému je vystavený. Základná charakteristika tried:

- Trieda **A1** - výrobky, ktoré neprispievajú k požiaru
- Trieda **A2** - výrobky, ktoré významne neprispievajú k ďalšiemu rastu požiaru
- Trieda **B** - ako pri triede C, ale s prísnejšími požiadavkami
- Trieda **C** - ako pri triede D, vykazujúce obmedzené šírenie plameňa
- Trieda **D** - ako pri triede E so schopnosťou odolávať pôsobeniu malého plameňa po dlhší čas
- Trieda **E** - výrobky schopné odolávať pôsobeniu malého plameňa počas krátkočasového intervalu
- Trieda **F** - výrobky, ktoré nie je možné zaradiť do žiadnej z predchádzajúcich tried

Doplnková klasifikácia stavebných výrobkov podľa kritérií:

- a.) vývoj dymu:
 - s3 - žiadne obmedzenia množstva dymu nie je vyžadované
 - s2 - celkové množstvo dymu je obmedzené
 - s1 - prísnejšie ako pri s2
- b.) plameňom horiace kvapky
 - d2 - bez obmedzenia
 - d1 - žiadne kvapky/častice horiace dlhšie ako udáva časový interval
 - d0 - žiadne plameňom horiace kvapky/častice

Klasifikácia triedy reakcie na oheň podľa STN EN 13501-2010 (pre stavebné výrobky)		Stupeň horľavosti podľa STN 73 0861, STN 73 0862 (pôvodný systém pre stavebné materiály)	
A1	nehorľavé	A	nehorľavé
A2 s1d0		B	neľahko horľavé
ostatné A2, B	horľavé	C1	ťažko horľavé
C		C2	stredne horľavé
D,E		C3	ľahko horľavé
F			

Najpredávanejšie izolačné tvarovky.

Prehľad najžiadanejších izolačných skruží, ktoré sa používajú na izolovanie oceľových potrubí. Skruže z minerálnej vlny s ALS povrchom a samolepiacim presahom v pozdĺžnom smere v dĺžke 1m typ **Rockwool 800** a 1,2m typ **Paroc Section Alu Coat T**.

Vonk. Ø potr. (mm):	Vnút. Ø potr. (mm):	Najpoužívanejšie rozmery tvaroviek s ALS fóliou podľa hrúbky izolácie (mm)						
		20	30	40	50	60	80	100
15		15/20						
18	DN15	18/20						
22	DN18	22/20	22/30					
28	DN20	28/20	28/30					
35	DN25	35/20	35/30	35/40				
42	DN35	42/20	42/30	42/40				
48	DN40	48/20	48/30	48/40	48/50			
54			54/30	54/40	54/50			
60	DN50	60/20	60/30	60/40	60/50	60/60		
64			64/30	64/40	64/50			
76	DN65		76/30	76/40	75/50	76/60	76/80	
89	DN80		89/30	89/40	89/50		89/80	
108	DN100		108/30	108/40	108/50			108/100
114					114/50			114/100
133	DN125				133/50			133/100
159	DN150				159/50			159/100
219	DN200				219/50			219/100

- hrúbky izolácie podľa vyhlášky 14/2016 Z.z
- väčšie hrúbky izolácie je možné použiť v prípade prísnejšej požiadavky na hrúbku izolácie s cieľom dosiahnuť maximálnu energetickú úsporu atď.
- menšie hrúbky izolácie všade tam, kde to nevyžaduje vyhláška alebo ak nieje možné na potrubie aplikovať izoláciu z dôvodu nedostatku miesta a pod.

Úspora tepla pri zaizolovanom potrubí (skruže Rockwool 800)

Výpočty boli vykonané pre teplotu média 55 °C a teplotu okolia 18 °C. Úspora je rozdiel medzi neizolovaným potrubím a zaizolovaným potrubím s izolačným púzdrom ROCKWOOL 800.

Vonk. Ø potr. (mm):	Úspory tepla pri použití potrubného puzdra ROCKWOOL 800 pre hrúbky izolácie (mm)						
	20	30	40	50	60	80	100
15	75%	79%					
18	77%	80%					
22	78%	81%	84%				
28	79%	83%	85%				
35	80%	84%	86%	87%			
42	81%	84%	86%	88%			
48	81%	85%	87%	88%			
54	81%	85%	87%	89%			
60	82%	85%	88%	89%	90%		
64	82%	85%	88%	89%	90%		
76		86%	88%	89%	90%		
89		86%	88%	90%	91%	92%	93%
108		86%	89%	90%	91%	93%	93%
114		87%	89%	90%	91%	93%	93%
133		87%	89%	90%	91%	93%	94%
159				91%	92%	93%	94%
219				91%			

PERINSUL

TEPELNÁ IZOLÁCIA, NA KTOREJ MÔŽETE STAVAŤ!

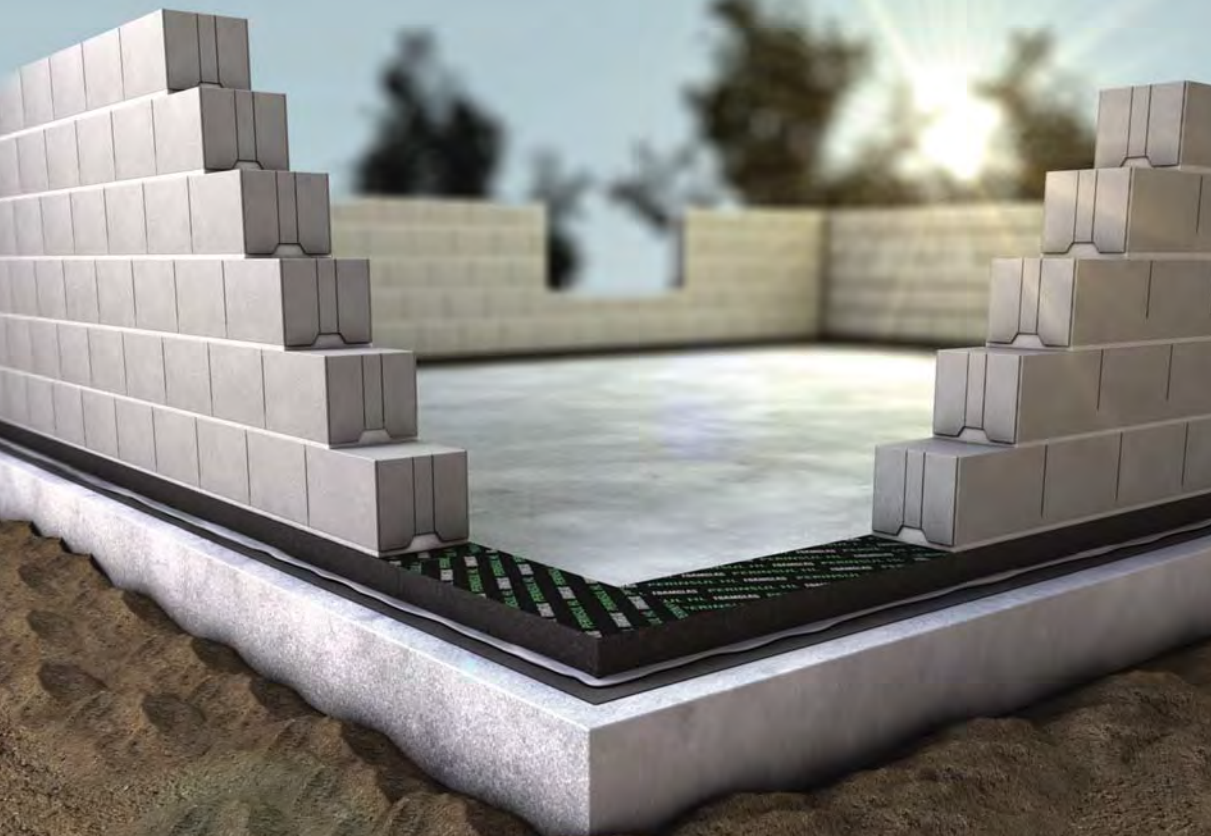

PERINSUL - DOKONALÉ RIEŠENIE PRE ODSTRÁNENIE TEPELNÝCH MOSTOV

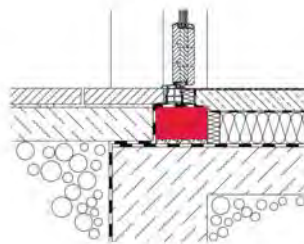
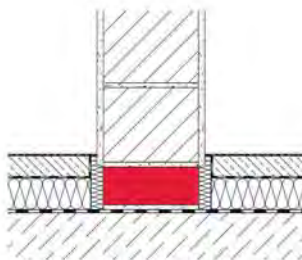
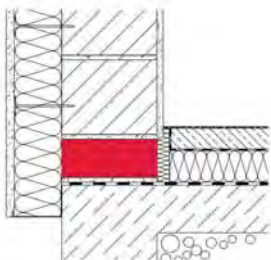



ALNA 2.0

Vďaka nažehľeným reflexným prvkom a mäkkým pohodlným látkam je Alna 2.0 ideálnou voľbou pre odolné, pohodlné a moderné pracovné odevy z kolekcie Hi-Vis.

Vrchné bundy s priedušnou a vodeodolnou membránou Helly Tech® Professional.

HELLY TECH®
P R O F E S S I O N A L

Nohavice s dvojcestným strečovým materiálom a výstužami Cordura®.



CHELSEA EVOLUTION

Elegantné a jednoduché línie dizajnu v kombinácii s progresívnym výberom látok Vám dávajú koncept vytvorený pre budúcnosť.

Vrchné bundy s priedušnou a vodeodolnou membránou Helly Tech® Professional.

HELLY TECH®
P R O F E S S I O N A L

Nohavice so štvorcestnou strečovou textíliou vo vybraných oblastiach a výstužami Cordura®.



OXFORD

Jedinečná, spoľahlivá a pohodlná: Jedna z našich najpredávanejších kolekcií z bavlnených materiálov.

Vrchné bundy s priedušnou a vodeodolnou membránou Helly Tech® Performance.

HELLY TECH®
P E R F O R M A N C E

Nohavice s obojstranne pružnou textíliou vo vybraných oblastiach a nylonovými výstuhami.



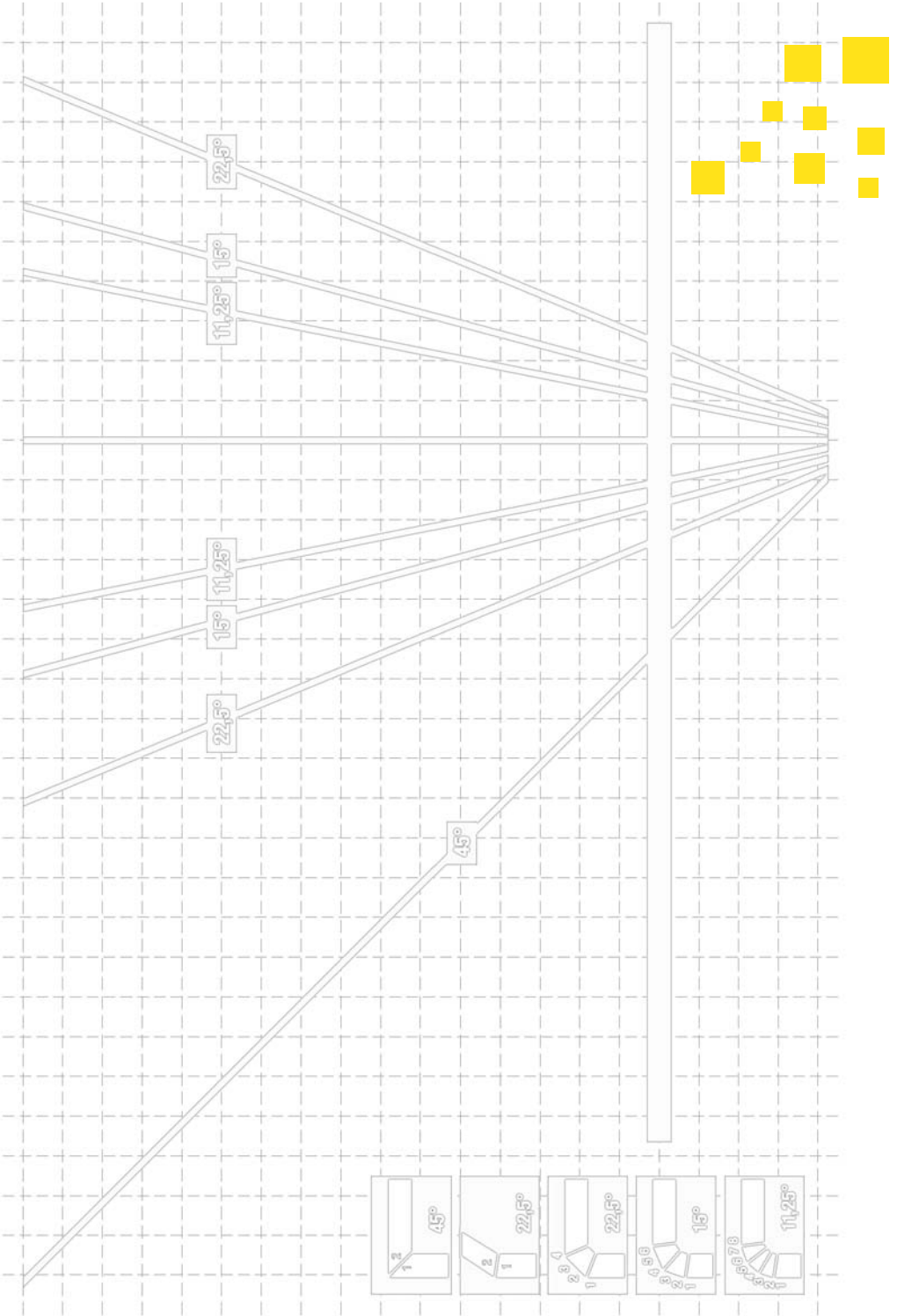

AZ FLEX, s.r.o.

Sídlo: Štrková 968/10C, 010 09 Žilina - Bytčica
IČO: 36422851
IČ DPH: SK2021876032
Zápis v OR: Okresný súd Žilina, oddiel Sro, vložka 15429/L

Peňažný ústav: ČSOB, a.s.
IBAN: SK83 7500 0000 0040 1966 5166
BIC (SWIFT): CEKOSKKBX

Ekonomické oddelenie
Mgr. Katarína Vojtušová
+421 911 944 296
azflex@azflex.sk

Otváracie hodiny pobočiek
pondelok - piatok
7.30 - 16.00

POBOČKA ŽILINA



AZ FLEX Žilina
Štrková 968/10c
010 09 Žilina - Bytčica

Technické a obchodné oddelenie
Marián Šustek
+421 911 944 297
sustek@azflex.sk

Oddelenie odbytu
zilina@azflex.sk
Zuzana Kováčová
+421 910 944 298
Marko Fondati
+421 910 944 297

POBOČKA BRATISLAVA



AZ FLEX Bratislava
Staviteľská 7
831 04 Bratislava

Technické a obchodné oddelenie
Erika Gajdošová
+421 917 093 123
gajdosova@azflex.sk

Oddelenie odbytu
bratislava@azflex.sk
Jaroslav Fečko
+421 911 944 294
Andrej Tománek
+421 911 944 295

POBOČKA KOŠICE



AZ FLEX Košice
Rampová 5
040 01 Košice

Technické a obchodné oddelenie
Miroslav Gladič
+421 911 944 288
gladic@azflex.sk

Oddelenie odbytu
kosice@azflex.sk
Peter Tivadar
+421 911 944 289
Mário Harakály
+421 905 696 609
Soňa Halászová
+421 915 110 040